













# ESSENTIAL edition

Excellent quality, optimum features



# Table of contents

Terminal blocks	Page 4		Industrial communication	Page 100	
Surge protection	Page 34		Sensor/actuator cabling	Page 106	
Power supplies	Page 54		Marking and labeling	Page 120	
Relay modules	Page 62		Tools and mounting material	Page 132	
Timer and monitoring relays	Page 76				
Safety relays	Page 82				
Energy monitoring	Page 88				
Signal conditioner	Page 94				

# Terminal blocks

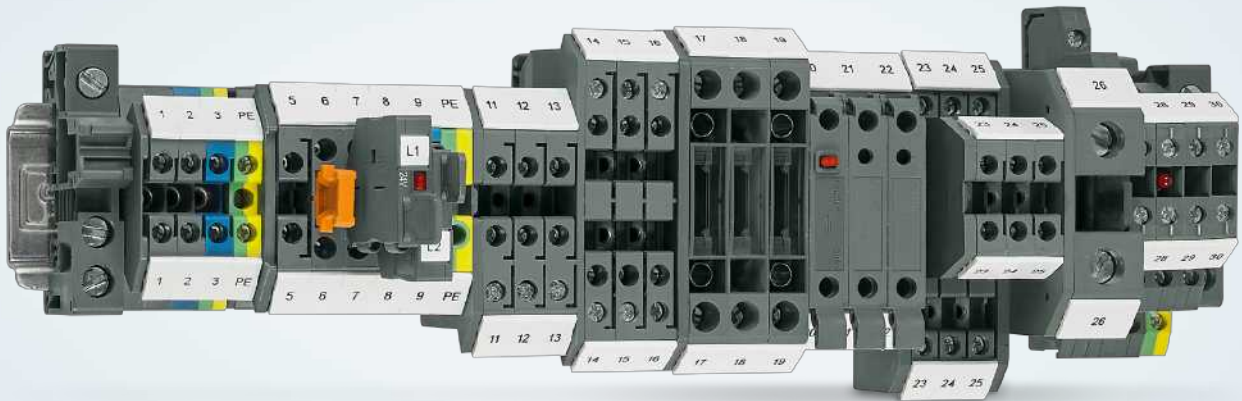

## Terminal blocks

Screw connections continue to dominate industrial connection technology. No other connection technology can achieve such high contact forces in a confined space. Thanks to the modular structure and comprehensive range of accessories, tailor-made solutions can be configured for every application.

## Product range overview

TB screw connection terminal blocks	<b>20</b>
BC screw connecting plug	<b>29</b>

## Terminal blocks

### Quality features

---

#### Quality in every application



With the comprehensive product range, the terminal blocks are ideal components for applications in a wide range of industrial fields. Numerous quality tests have proven that even under harsh conditions, the TB terminal blocks transmit signals and distribute energy reliably and safely.



**Infrastructure**



Measuring devices can be looped in quickly and easily with knife disconnect terminal blocks to check the system during startup and maintenance. The terminal blocks with disconnect zone, which are the same shape, also allow component connectors or fuse plugs to be used to protect the signals.  
Corrosion test:  
DIN 50018

**Power engineering**



The TB series is ideal for the energy supply sector with its individual and easily configurable measuring transducer sets for all current transformer and voltage transducer applications.  
Touch proofness:  
IEC 60529 / DIN EN 50274

**Wind power**



When it comes to the modular structure of wind turbine generators, the TB terminal blocks with connector help prevent wiring errors and save time.  
Vibration test:  
IEC 60068-2-6

**Machine building**



The amount of wiring effort and space required when connecting sensors and actuators can be reduced considerably with the TBIO. Temporary high currents, e.g., when starting up electric motors, present no problem for the TB terminal blocks.  
Short-time withstand current:  
IEC 60947-7-1/-2

**Signal technology**



Signals can be transmitted safely in a confined space with the compact double-level terminal blocks. Thanks to the use of modern materials, the TB terminal blocks are also ideal for use in challenging environments, such as atmospheres containing salt or at temperatures as low as -60°C.  
Salt spray:  
IEC 60068-2-11/-52

**Photovoltaics**



Conductors with a larger cross section are used for the connection between SCBs and inverters due to the higher currents and longer cable lengths. TB terminal blocks can accommodate conductors up to a cross section of 240 mm<sup>2</sup>.  
Conductor pull-out test:  
IEC 60947-7-1/-2

#### Quality tests

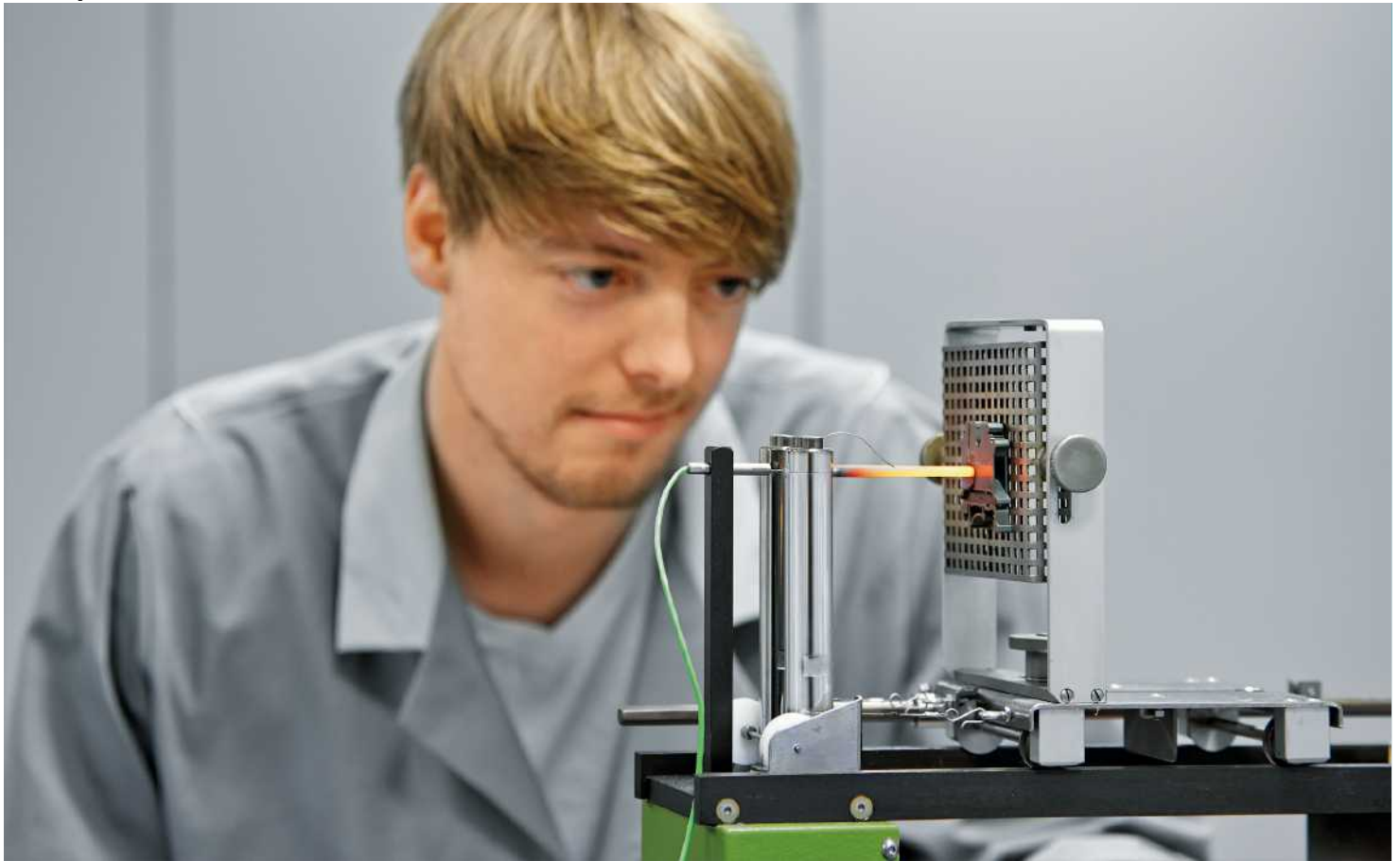

Reliable connections - that is our everyday motto. The quality of our products is the key. This is not tested subsequently on finished products, but is ensured responsibly during every step of production. TB terminal blocks represent compact, high-performance electrical connections. High-quality physical properties and advanced industrial standards are evidenced by connections with long-term stability. This high quality is demonstrated by recognized tests which are documented in national and international standards.

Test sequence for terminal blocks in accordance with IEC 60947-7-1/2:

- Connection capacity
- Mechanical strength
- Bending test – flexion test
- Conductor pull-out test
- Modular terminal block fixed securely
- Air clearances and creepage distances
- Impulse withstand voltage test
- Voltage drop test
- Temperature-rise test
- Short-time current resistance
- Dielectric test
- Aging test
- Needle flame test



## Conductor pull-out test

### IEC 60947-7-1/-2

In practice, tensile forces can affect the terminal point during wiring or operation. Correctly wired terminal blocks must therefore offer a high degree of mechanical safety. To test the tensile load capacity of a terminal point, the terminal point must withstand a given tensile force based on the cross section for over 60 seconds. This test is performed after the flexion test. Performing these two tests directly one after the other intensifies the requirements. The tensile force exerts stress on the conductor at the terminal point. The conductor must be held without causing damage. The TB screw terminal blocks withstand tensile forces up to 100% above the required minimum values.

Conductor cross section		Tractive force [N]
[mm <sup>2</sup> ]	AWG / kcmil	
0.2	24	10
	...	
4	12	60
	...	
240	500	578

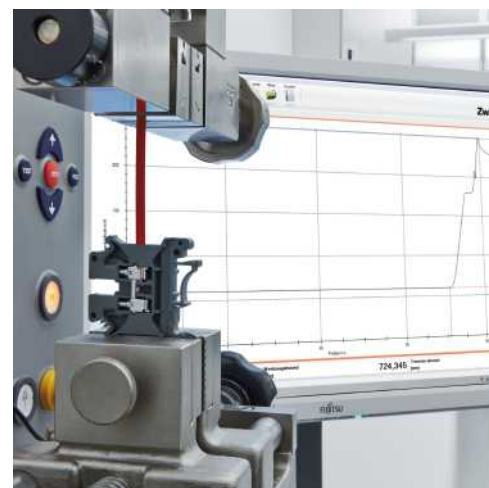

Absorption of tensile force at a 6 mm<sup>2</sup> screw terminal block

## Short-time current resistance

### IEC 60947-7-1/-2

Terminal blocks must, in practice, also be capable of resisting short-circuit currents until the relevant safety equipment cuts off the current without sustaining any damage. This can take up to several tenths of a second.

For testing purposes, a terminal block is mounted on the support and wired to a conductor with the rated cross section. Protective conductor terminal blocks are subjected in three stages of one second each to a current density of 120 A/mm<sup>2</sup> with the rated cross section.

The requirements are met if, after the test, the individual parts are undamaged and they can still be used.

Before and after the test, the terminal block must pass the voltage drop test. The voltage drop before and after the test must not exceed 3.2 mV per terminal block and also must not exceed 1.5 times the value measured before the test.

In the case of the TB 240 I high-current terminal block, a test current of 28,800 A is passed through the terminal block for one second without loss of quality.

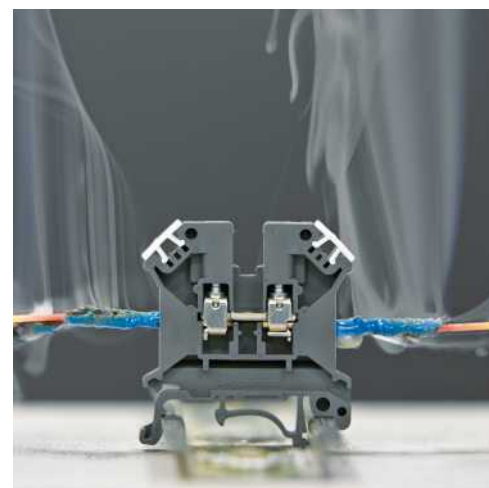

Maximum contact reliability, even under extreme overload.

# Terminal blocks

## Quality features

---

### Corrosion test

#### DIN 50018

The key role of the metal parts of electrical connections becomes particularly apparent in aggressive environments. Corrosion-free contact areas are a prerequisite for low-resistance and therefore high-performance connections. This test method describes a corrosion test in condensation climates with an atmosphere that contains sulfur dioxide. Acidic compounds < Ph 7 form during the test and attack the metal surfaces. Two liters of distilled water and one liter of SO<sub>2</sub> gas are introduced into the test chamber. Sulfurous acid forms at a testing temperature of 40°C during the course of the test.

After eight hours of testing, the test objects are left to dry for 16 hours with the door open. At the end of the test, the test objects are visually inspected, and the contact resistance is measured in order to show the influence of this corrosion test on the contact point in more detail. The TB series from Phoenix Contact creates high-quality, gas-tight connections that cannot be impaired even by corrosive substances.



## Aging test

### IEC 60947-7-1/-2

From the point of view of long lifecycles of the terminal blocks, the aging behavior also plays an important role.

In this test, the contact quality is verified by means of simulated aging.

To simulate several years of use, five terminal blocks are mounted horizontally on a rail and connected in series using conductors with the rated cross section. Conductors with a minimum length of 300 mm are connected and the voltage drop is measured at every terminal block. The minimum temperature in the climate cabinet is set to 20°C and the maximum temperature to 85°C.

During the heating phase and the 10-minute pause phase with maximum temperature, the rated current flows. As a result, the maximum permissible operating temperature of the test object

(max. 130°C) is reached. The cooling down phase follows. The voltage drop is always measured after 24 cycles in the cooled down state (approximately 20°C). The test consists of a total of 192 cycles.

The voltage drop must not exceed 3.2 mV initially. During or after testing, it must not exceed 4.8 mV or 1.5 times the value measured after the 24th cycle.

TB terminal blocks are designed for extreme durability even under difficult temperature conditions. Plastic as well as metal parts provide sufficient safety reserves.

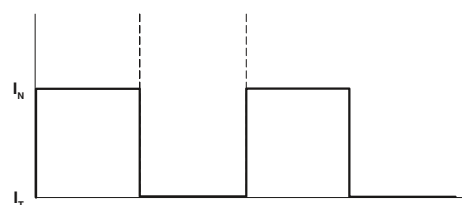
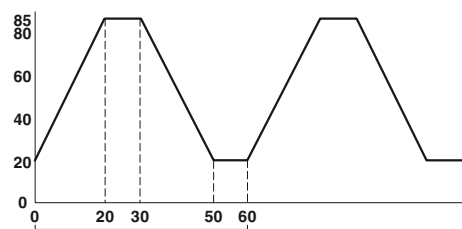

Current and temperature in relation to time



# Terminal blocks

## Quality features

---

### Salt spray

#### IEC 60068-2-11/-52

Particularly in shipbuilding, technical components have to function continuously in corrosive atmospheres. The salt content of the air combined with the increased humidity places high demands on the metal parts used. The impact of the climate at sea can be simulated on the basis of the above standard.

The resistance of the materials is tested with salt spray in a corrosive atmosphere. The test objects are placed in the test chamber and subjected to a finely dosed spray of 5% sodium chloride solution (NaCl; pH value 6.5 - 7.2) at a temperature of 35°C for a period of 96 hours.

At the end of the test, the test objects are visually inspected and an electrical test is performed to show the influence of this corrosion test on the contact point in more detail.

The TB terminal blocks create a gas-tight connection to the connected conductors. This means that the contact point is protected against corrosion even under extreme climatic conditions.

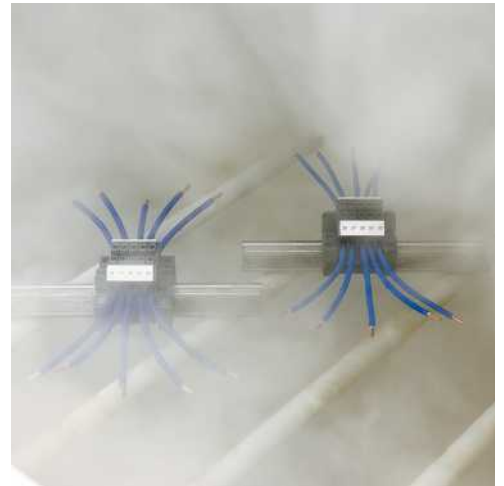

## Voltage drop test

### IEC 60947-7-1/-2

In every terminal point of a terminal block, one or more conductors are connected - depending on the connection technology. Current transfer is strongly affected by the electrical resistance between the conductor and the current bar. High-quality contacts create a gas-tight connection. This is the only way to ensure a permanently reliable connection. This electrical test therefore determines the voltage drop on a terminal block (two terminal points). Conclusions regarding the contact resistance and the contact quality can therefore be made. The terminal blocks are wired with the rated cross section. For measuring purposes, the terminal blocks are charged with a di-

rect test current corresponding to 0.1 times the current carrying capacity of the rated cross section. The voltage drop is measured at a distance  $\leq 10$  mm from the center of the terminal point (see diagram).

At a room temperature of  $\sim 20^{\circ}\text{C}$ , the voltage drop must not exceed 3.2 mV per terminal block before or after the test, nor must it exceed 1.5 times the value measured at the start of the test.

TB terminal blocks are up to 60% below the limit values required by standards.

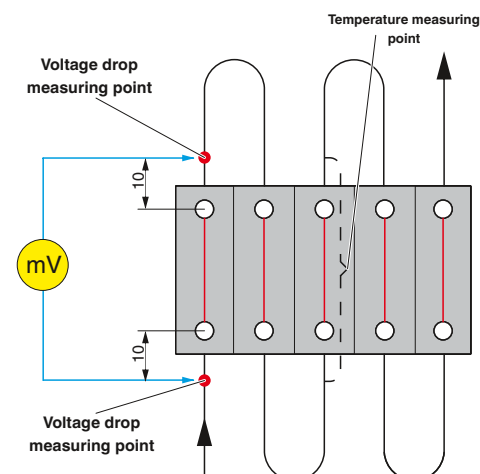

Rated cross section [mm <sup>2</sup> ]	Current carrying capacity [A]	Rated cross section AWG	Current carrying capacity [A]
0.2	4	24	4
0.5	6	20	8
0.75	9	18	10
1	13.5	-	-
1.5	17.5	16	16
2.5	24	14	22
4	32	12	29
6	41	10	38
10	57	8	50
16	76	6	67
35	125	2	121
50	150	0	162
95	232	0000	217
150	309	00000	309
240	415	500 MCM	415

## Terminal blocks

### Quality features

#### Needle flame test

##### IEC 60947-7-1/-2

As far as the use of terminal blocks is concerned, behavior in fire when in direct contact with a source of ignition is a major criterion. Such sources of ignition could be electric arcs along a creepage distance, for example. Terminal blocks must not aid or accelerate fires and the plastics must have self-extinguishing properties.

This fire test simulates the behavior of the components with an external source of ignition acting on them directly from outside. In the test, a naked flame fed with butane gas is held at an edge or surface of the test object at an angle of 45° for 10 seconds (see figure). The behavior of the test object without a source of ignition is then observed.

The test is deemed to be passed when the flames or glowing processes are extinguished within 30 seconds of the flame being removed and when the tracing paper beneath the test object is not ignited by falling drops of burning substances.

All TB terminal blocks pass the needle flame test, thanks to the high-grade plastics used and their structural design.

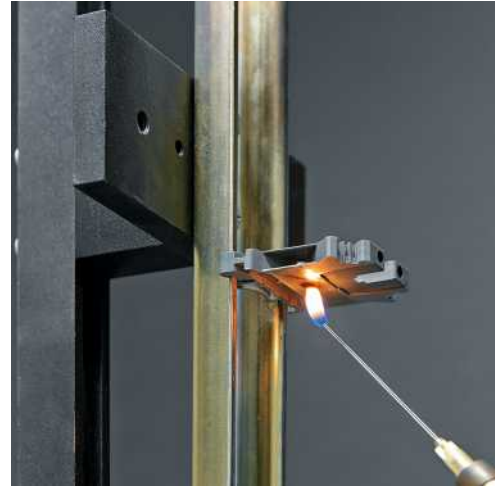

#### Glow-wire test

##### IEC 60695-2-11

In the event of overload, conductive metal parts of the terminal block or connected conductors can heat up considerably. This additional heat affects the plastic housing. To simulate this source of danger for electrotechnical components, a glow wire is heated to a specific temperature (550°C, 650°C, 750°C, 850°C or 960°C) in a glow-wire test and is then pushed onto the thinnest part of the housing of the test object at a right angle with a force of 1 N, as shown in the figure. The test is deemed to be passed:

- When no flame or glowing process occurs during the test
- When the flames or glowing processes are extinguished within 30 seconds of the glow wire being removed

– When the tracing paper beneath the glow wire does not ignite due to any drops of burning substances falling down

The polyamides used for the TB terminal blocks as housing materials all meet the requirements of the glow-wire test at 960°C (highest level).

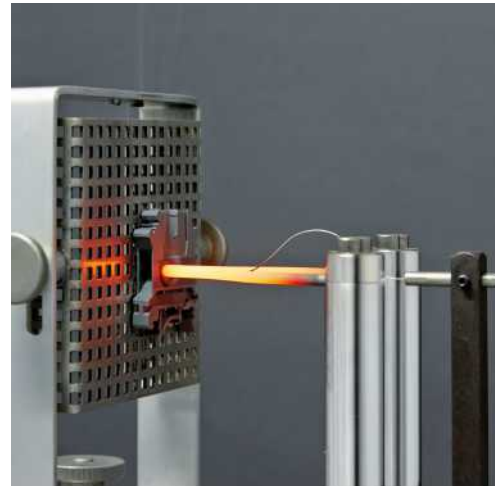



## Inflammability classification

### UL 94

UL 94 describes inflammability tests that have gained particular importance in the field of electrical engineering. Behavior in fire is the main focus. Items are classified in accordance with either UL 94 HB (Horizontal Burn) or UL 94 V (Vertical Burn). The test setup is such that the 94 V0/1/2 classifications are stricter than the 94 HB classification.

### UL 94 V0/1/2

After conditioning, the test bar is vertically clamped and flame-treated several times for 10 seconds at a time. Between the flame

treatments, the time until the test bar is extinguished is measured. Afterwards, the afterburning times and the drip behavior are evaluated. The plastic used for TB terminal blocks meets the higher-grade criteria for classification as a V0 material.

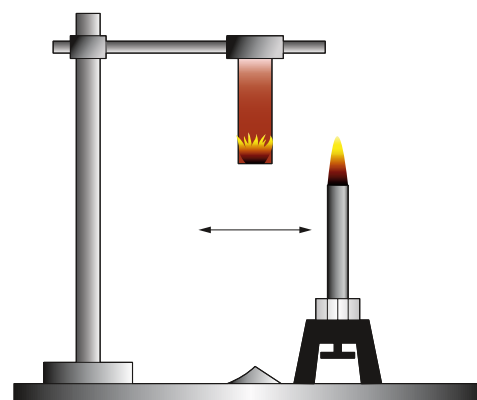

Classification	UL 94 V0	UL 94 V1	UL 94 V2
Burning time after each flame treatment	≤ 10 s	≤ 30 s	≤ 30 s
Total burning time after 10 flame treatments	≤ 50 s	≤ 250 s	≤ 250 s
Glowing time after the 2nd flame treatment	≤ 30 s	≤ 60 s	≤ 60 s
Complete burn-off	No	No	No
Ignition of the absorbent cotton under the sample	No	No	No

## Behavior in fire

### NF F 16-101

NF F 16-101 describes the behavior in fire of plastics on the basis of two indices (I and F). As such, the following tests are performed: glow-wire test, oxygen index, smoke gas opacity, smoke gas toxicology.

#### 1. Determination of index I (0 - 4)

Index I is determined from the results of the glow-wire test and the oxygen index, using the following table. Here, I 0 is the best classification and I 4 the worst.

Index	Oxygen index	Glow wire
I 0	70 %	960°C, no flame formation
I 1	45 %	960°C, no flame formation
I 2	32 %	960°C, no flame formation
I 3	28 %	850°C, no flame formation
I 4	20 %	850°C, flame extinguishes quickly

2. Determination of smoke index F (0 - 5)  
This is based on the smoke gas opacity and the smoke gas toxicity. The following concentrations in [ppm] are considered critical:

Carbon monoxide (CO)	1750
Carbon dioxide (CO <sub>2</sub> )	90000
Hydrochloric acid (HCl)	150
Hydrobromic acid (HBr)	170
Hydrocyanic acid (HCN)	55
Hydrofluoric acid (HF)	17

Using the test results, a smoke index is documented and can be assigned to classes F 0 – F 5 depending on the value. Here, F 0 is the best classification and F 5 the worst. The TB terminal blocks attain classification I 2/F 2.

# Terminal blocks

## Quality features

### Smoke gas toxicity

#### SMP 800-C

SMP 800-C describes the maximum permissible values of toxic smoke gases when a plastic is burned. In comparison to the BSS 7239 (Boeing standard), this standard specifies more precise measuring methods for the qualitative and quantitative determination of toxic smoke gases that result when a test object is completely burned. The smoke gases of these measurements are taken from the NBS test chamber of the ASTM E 662 test. The same time scheme is valid here as in ASTM E 662.

This fire test simulates the behavior of the components with an external source of ignition acting on them directly from outside.

Data is recorded over a full 20 minutes.

SMP 800-C limit values of toxic smoke gases in ppm:

Carbon monoxide (CO)	3500
Carbon dioxide (CO <sub>2</sub> )	90000
Nitrogen oxides (NO <sub>x</sub> )	100
Sulfur dioxide (SO <sub>2</sub> )	100
Hydrochloric acid (HCl)	500
Hydrobromic acid (HBr)	100
Hydrofluoric acid (HF)	100

The polyamides used for the TB series are many times below the critical concentrations.

### Surface inflammability

#### ASTM E 162

The spread of a fire under the influence of heat is tested and evaluated in the above standard.

To evaluate the surface inflammability of plastics, a “flame spread index” is devised in accordance with ASTM E 162 to provide information on flame propagation under given test conditions.

For this purpose, a sample (152 x 457 x maximum 25.4 mm) is irradiated with a heat source (815°C) at an angle of 30° and ignited with a naked flame at the top end. During the 15-minute duration of the test, the time in which the flame front reaches two measuring points that are 76 mm apart is determined. The product of this flame propagation time and a calculated heat development factor yields the “flame spread index”.

In the American railroad sector, the maximum limit value is 35. In this test, the drip behavior of the plastic is also observed and evaluated.

The TB terminal blocks from Phoenix Contact achieve a flame spread index of 5, drip without burning, and are therefore well below the maximum permitted values of the Federal Railroad Administration (FRA) of the US Department of Transportation.

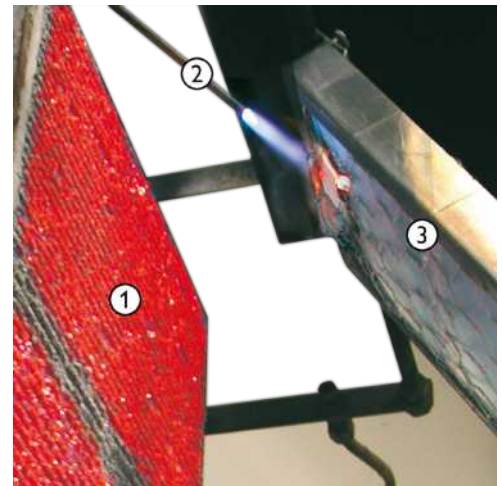

- ① Radiant heater
- ② Flame
- ③ Plastic sample

## Vibration test

### IEC 60068-2-6

This test demonstrates the vibration resistance of a terminal connection subjected to permanent vibrations. Harmonic, sinusoidal vibrations are applied to the test object to simulate rotating, pulsating or oscillating forces. The test is performed on each of the three spatial axes (X, Y, Z). In the test, the objects run through a frequency range of 5 Hz to 150 Hz at a speed of one octave per minute. The r.m.s. value of the acceleration is up to 40 m/s<sup>2</sup>. The test objects are tested for two hours on each of the three axes (x, y, z).

No damage may occur to the terminal blocks that would impair their further use. In addition, no contact interruptions of > 1 µs are permitted during the test. The contact resistance is measured before and after the test.

TB terminal blocks meet the requirements of the standard without the electrical contact being interrupted. They are therefore particularly suitable for challenging applications in which the reliable function of the terminal connection must be ensured, even when subjected to vibrations.

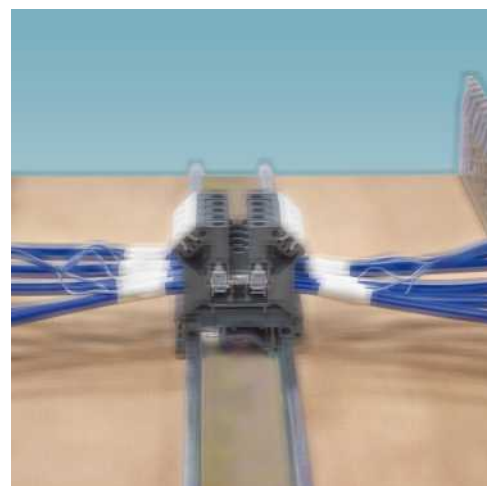

## Touch proofness

### IEC 60529 / DIN EN 50274

Electrical installations and plants must also afford service technicians a high level of safety when carrying out maintenance involving measuring and testing tasks.

BGV A2 specifies safety distances for work, operation, and occasional handling near parts that pose a potential danger in low-voltage plants up to 1000 V AC and 1500 V DC, based on standard IEC 60529. For the purpose of contact safety, a distinction is made between back-of-hand safety and finger safety (touch proofness). The extent to which conductive parts are safe to touch is tested with a test finger and test ball. It must not be possible to touch conductive parts with the test equipment.

TB terminal blocks offer finger and contact safety.



Test finger Ø 12,5 mm



Test ball Ø 50 mm

# Terminal blocks

## Quality features

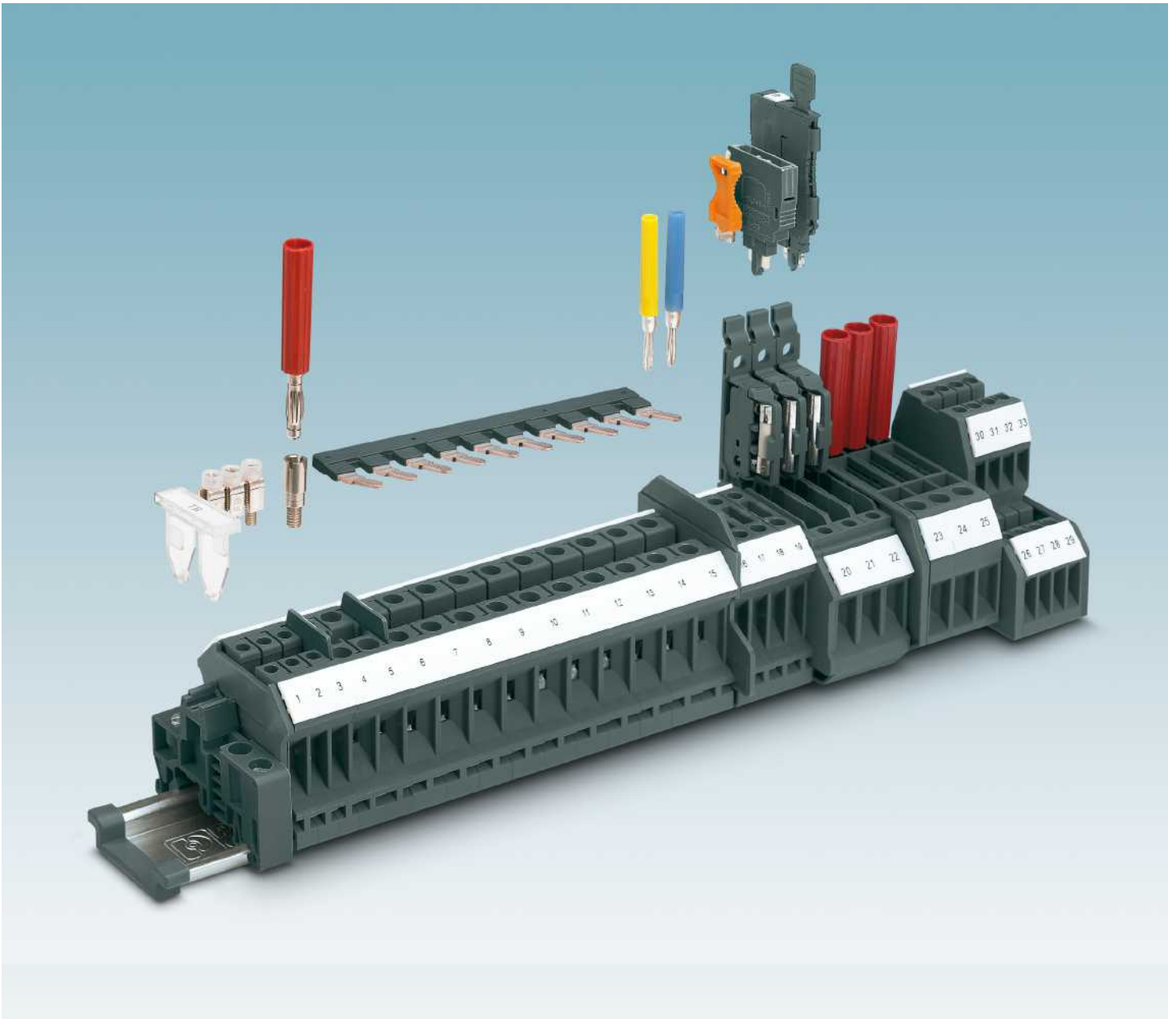

### Compact design

Thanks to the space-saving design, the TB modular terminal blocks are ideal for control systems where limited space is available.

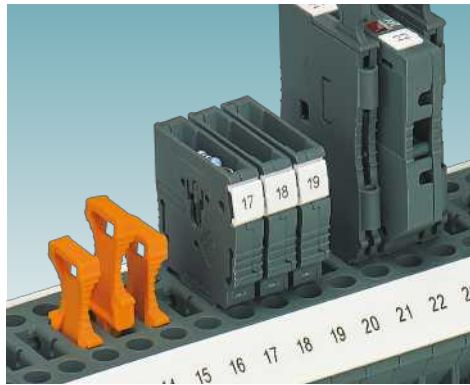
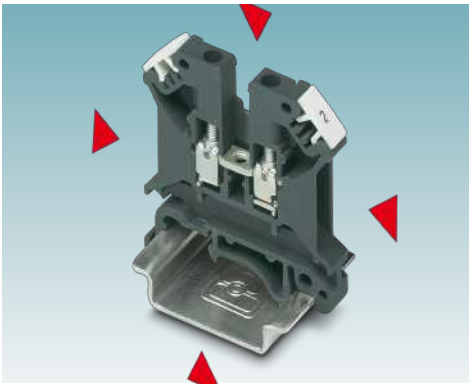





If used with the corresponding fixed bridges, the RB TB... reducing bridges allow terminal blocks with different nominal cross sections to be connected. This means that power blocks can be easily created.

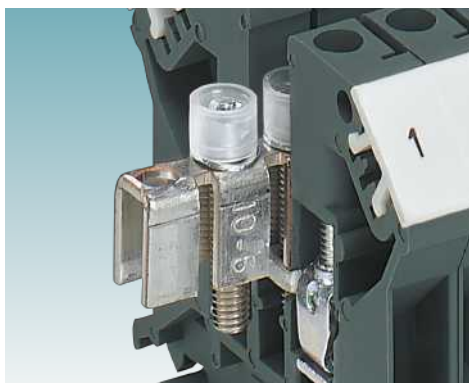

Any number of positions can be easily disconnected from the 10-pos. strip of the SCBI ... fixed bridge with insulating cap, placed in the bridge shaft, and screwed tight.



Any number of terminal blocks can be easily bridged according to the application using the MSCB ... modular chain bridges.

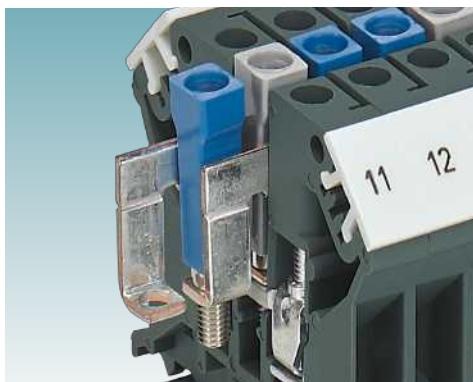

The L bridges can be used to route two different potentials in the bridge shaft. Insulated and color-coded contact screws clearly indicate the relevant potential.

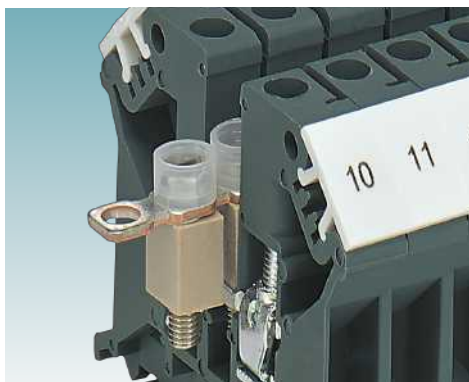

The SCBI ...ISO isolator bridge bars support switchable cross connections. Here the screw has the function of a live contact.

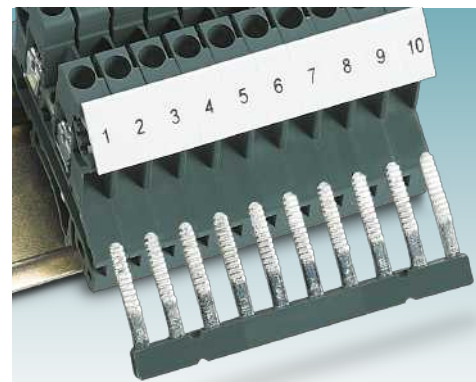

The INB ... isolated insertion bridges are simply clamped down at the connection points, with or without conductors. The bridges can be assembled as required for the number of positions. Individual forks are removed for bridging between non-adjacent terminal blocks.



PSB ... test sockets which can be screwed into the bridge shaft enable reliable test points for 2.3 mm and 4 mm test plugs. The 2.3 mm MPS ... test plug makes direct contact in the bridge shaft when using terminal blocks with an overall width of 5.2 mm and 6.2 mm.



The TS-TB insulation plate is used to electrically isolate and visually separate two neighboring bridges. An insulation plate should be placed on both sides of the bridge in order for the terminal blocks to retain their complete nominal voltage.

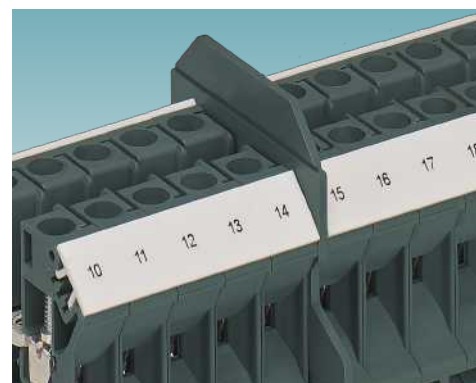

The partition plates protrude beyond the terminal block contours. They provide visual as well as electrical group separation.

# Terminal blocks

## TB screw connection terminal blocks

### Feed-through terminal block, 0.5 - 4 mm<sup>2</sup>, 24 A, width 5.2 mm

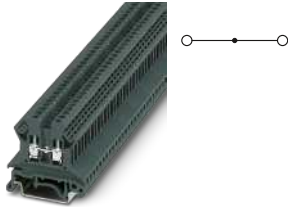

#### Common technical data

Connection cross section, Level 1 above 1 below 1, rigid / flexible	0.5 mm <sup>2</sup> - 4 mm <sup>2</sup> / 0.5 mm <sup>2</sup> - 2.5 mm <sup>2</sup>
Screw connection	20 - 12 AWG / 20 - 14 AWG
Tightening torque	0.4 Nm - 0.5 Nm
Width	5.2 mm
Length	42.5 mm
Height NS 35/7,5	42 mm
Number of connections	2
Insulation material / Flammability rating in accordance with UL 94	PA / V2

Nominal voltage U <sub>N</sub>	UL rated voltage	UL nominal current	Color	Type	Item No.	Pcs./Pkt.
800 V (630 V for 4 mm <sup>2</sup> connection)	600 V	20 A	dark gray	TB 2,5 EI	3246010	50
800 V	600 V	20 A	blue	TB 2,5 EI BU	3246719	50
800 V	-	-	red	TB 2,5 EI RD	3000849	50
800 V	-	-	yellow	TB 2,5 EI YE	3000853	50
800 V	-	-	black	TB 2,5 EI BK	3000854	50
800 V	-	-	green	TB 2,5 EI GN	3246720	50

Accessories	Type	Item No.	Pcs./Pkt.
End cover, width 1.5 mm, dark gray	D-TB 2,5 E	3246094	50
Screw bridge, 10-position, silver, with insulating collar	SCBI 10-5 N	3246117	10
Insertion bridge, 10-position, gray, Bridging in the terminal point	INB 10-5	3246175	10
Separating plate, width 0.5 mm, for electrical isolation of neighboring bridges in the terminal center	TS-TB-2L	3062841	50
Partition plate, width 3 mm, dark gray	ATP-TB	3046272	50
Screwdriver	SZS 0,6X3,5 VDE	1212602	10
Female test connector, for 2.3 mm test plugs, for screwing into the bridge shaft	TPS 3/10/4	3246230	10
End block	E/TB	3246966	50

### Feed-through terminal block, 0.5 - 6 mm<sup>2</sup>, 32 A, width 6.2 mm

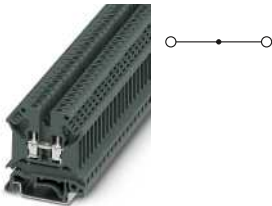

#### Common technical data

Connection cross section, Level 1 above 1 below 1, rigid / flexible	0.5 mm <sup>2</sup> - 6 mm <sup>2</sup> / 0.5 mm <sup>2</sup> - 4 mm <sup>2</sup>
Screw connection	20 - 10 AWG / 20 - 12 AWG
Nominal voltage U <sub>N</sub>	800 V (in the case of enclosed clamping space)
Tightening torque	0.5 Nm - 0.6 Nm
Width	6.2 mm
Length	42.5 mm
Height NS 35/7,5	47 mm
Number of connections	2
Insulation material / Flammability rating in accordance with UL 94	PA / V2

UL rated voltage	UL nominal current	Color	Type	Item No.	Pcs./Pkt.
600 V	30 A	dark gray	TB 4 EI	3246023	50
600 V	30 A	blue	TB 4 EI BU	3246722	50
-	-	red	TB 4 EI RD	3000855	50
-	-	yellow	TB 4 EI YE	3000856	50
-	-	black	TB 4 EI BK	3000857	50
-	-	green	TB 4 EI GN	3246723	50

Accessories	Type	Item No.	Pcs./Pkt.
End cover, width 1.5 mm, dark gray	D-TB 4/10 E	3246104	50
Fixed bridge, 10-position, silver	SCBI 10-6	3246120	10
Insertion bridge, 10-position, gray, Bridging in the terminal point	INB 10-6	3246188	10
Separating plate, for electrical isolation of neighboring bridges in the terminal center	TS-TB	3062838	50
Partition plate, width 3 mm, dark gray	ATP-TB	3046272	50
Screwdriver	SZS 0,6X3,5 VDE	1212602	10
Female test connector, for 2.3 mm test plugs, for screwing into the bridge shaft	TPS 3/10/4	3246230	10
End block	E/TB	3246966	50



**Feed-through terminal block, 1.5 - 6 mm<sup>2</sup>, 41 A, width 8.2 mm**

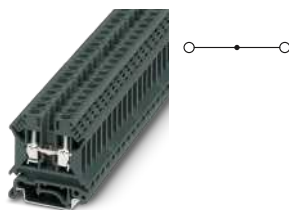

Common technical data	
Connection cross section, Level 1 above 1 below 1, rigid / flexible	1.5 mm <sup>2</sup> - 6 mm <sup>2</sup> / 1.5 mm <sup>2</sup> - 6 mm <sup>2</sup>
Screw connection	16 - 8 AWG / 16 - 8 AWG
Nominal voltage U <sub>N</sub>	1000 V (in the case of enclosed clamping space)
UL rated voltage	600 V
UL nominal current	45 A
Width	8.2 mm
Length	42.5 mm
Number of connections	2
Insulation material / Flammability rating in accordance with UL 94	PA / V2

Height NS 35/7,5	Color	Type	Item No.	Pcs./Pkt.
47.2 mm	dark gray	TB 6 EI	3246036	50
47 mm	blue	TB 6 EI BU	3246735	50
47 mm	red	TB 6 EI RD	3000859	50
47 mm	yellow	TB 6 EI YE	3000860	50
47 mm	black	TB 6 EI BK	3000862	50
47 mm	green	TB 6 EI GN	3246736	50

Accessories	Type	Item No.	Pcs./Pkt.
End cover, width 1.5 mm, dark gray	D-TB 4/10 E	3246104	50
Fixed bridge, 10-position, silver	SCBI 10-8	3246133	10
Insertion bridge, 10-position, gray, Bridging in the terminal point	INB 10-8	3246191	10
Separating plate, for electrical isolation of neighboring bridges in the terminal center	TS-TB	3062838	50
Partition plate, width 3 mm, dark gray	ATP-TB	3046272	50
Screwdriver	SZS 1,0X4,0 VDE	1205066	10
Female test connector, for 4 mm test plugs, for screwing into the bridge shaft	TPS 4/7/6	3246243	10
End block	E/TB	3246966	50

**Feed-through terminal block, 1.5 - 16 mm<sup>2</sup>, 57 A, width 10.2 mm**

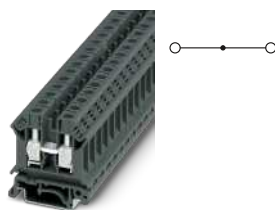

Common technical data	
Connection cross section, Level 1 above 1 below 1, rigid / flexible	1.5 mm <sup>2</sup> - 16 mm <sup>2</sup> / 1.5 mm <sup>2</sup> - 10 mm <sup>2</sup>
Screw connection	16 - 6 AWG / 16 - 8 AWG
Nominal voltage U <sub>N</sub>	1000 V (in the case of enclosed clamping space)
UL rated voltage	600 V
UL nominal current	50 A
Width	10.2 mm
Length	42.8 mm
Height NS 35/7,5	47 mm
Number of connections	2
Insulation material / Flammability rating in accordance with UL 94	PA / V2

Color	Type	Item No.	Pcs./Pkt.
dark gray	TB 10 EI	3246049	50
blue	TB 10 EI BU	3246748	50
red	TB 10 EI RD	3000863	50
yellow	TB 10 EI YE	3000864	50
black	TB 10 EI BK	3000865	50
green	TB 10 EI GN	3246750	50

Accessories	Type	Item No.	Pcs./Pkt.
End cover, width 1.5 mm, dark gray	D-TB 4/10 E	3246104	50
Fixed bridge, 10-position, silver	SCBI 10-10	3246146	10
Insertion bridge, 10-position, gray	INB 10-10	3246201	10
Separating plate, for electrical isolation of neighboring bridges in the terminal center	TS-TB	3062838	50
Partition plate, width 3 mm, dark gray	ATP-TB	3046272	50
Screwdriver	SZS 1,0X4,0 VDE	1205066	10
Female test connector, for 4 mm test plugs, for screwing into the bridge shaft	TPS 4/7/6	3246243	10
End block	E/TB	3246966	50

# Terminal blocks

## TB screw connection terminal blocks

### Feed-through terminal block, 6 - 16 mm<sup>2</sup>, 76 A, width 12.2 mm

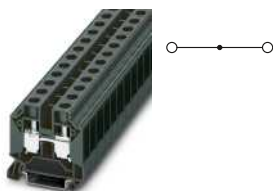

#### Common technical data

Connection cross section, Level 1 above 1 below 1, rigid / flexible	6 mm <sup>2</sup> - 16 mm <sup>2</sup> / 6 mm <sup>2</sup> - 16 mm <sup>2</sup>
Screw connection	10 - 6 AWG / 10 - 6 AWG
Nominal voltage U <sub>N</sub>	1000 V
UL rated voltage	600 V
UL nominal current	76 A
Tightening torque	2.5 Nm - 3 Nm
Width	12.2 mm
Length	51 mm
Height NS 35/7,5	50.5 mm
Number of connections	2
Insulation material / Flammability rating in accordance with UL 94	PA / V2

Color	Type	Item No.	Pcs./Pkt.
dark gray	TB 16 EI	5792172	1
blue	TB 16 EI BU	3214152	50
green	TB 16 EI GN	3214153	50

Accessories	Type	Item No.	Pcs./Pkt.
End cover, width 2.2 mm, dark gray	D-TB 16 E	5793004	50
Screw bridge, 10-position, silver, with insulating collar	SCBI 10-12	3246159	10
Insertion bridge, 10-position, gray, Bridging in the terminal point	INB 10-12	3246214	10
Screwdriver	SZS 1,0X6,5 VDE	1205079	10
Female test connector, for 4 mm test plugs, for screwing into the bridge shaft	TPS 4/7/6	3246243	10

### Feed-through terminal block, 10 - 35 mm<sup>2</sup>, 125 A, width 15.2 mm

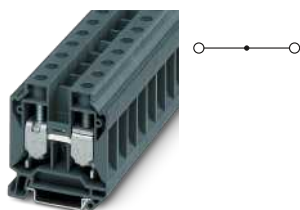

#### Common technical data

Connection cross section, Level 1 above 1 below 1, rigid / flexible	10 mm <sup>2</sup> - 35 mm <sup>2</sup> / 10 mm <sup>2</sup> - 35 mm <sup>2</sup>
Screw connection	8 - 2 AWG / 8 - 2 AWG
Nominal voltage U <sub>N</sub>	1000 V
Tightening torque	3.2 Nm - 3.7 Nm
Width	15.2 mm
Length	53.5 mm
Height NS 35/7,5	62.1 mm
Number of connections	2

UL rated voltage	UL nominal current	Insulation material / Flammability rating in accordance with UL 94	Color	Type	Item No.	Pcs./Pkt.
600 V	115 A	PA / V0	dark gray	TB 35 EI	5792173	50
600 V	115 A	PA / V2	blue	TB 35 EI BU	3214165	50
-	-	PA / V2	green	TB 35 EI GN	3214166	50

Accessories	Type	Item No.	Pcs./Pkt.
End cover, width 2.2 mm, dark gray	D-TB 35 E	5793005	50
Fixed bridge, 2-position, silver, with insulating collar	SCBI 2-15	3246162	10
Fixed bridge, 3-position, silver, with insulating collar	SCBI 3-15	3246573	10
Fixed bridge, 5-position, silver, with insulating collar	SCBI 5-15	3246612	10
Insertion bridge, 2-position, gray	INB 2-15	3246227	10
Screwdriver	SZS 1,0X6,5 VDE	1205079	10
Female test connector, for 4 mm test plugs, for screwing into the bridge shaft	TPS 6/5/6	3246256	10
End block	E/TB	3246966	50

### Feed-through terminal block, 16 - 70 mm<sup>2</sup>, 150 A, width 20 mm

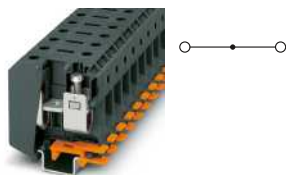

#### Common technical data

Connection cross section, rigid / flexible	16 mm <sup>2</sup> - 70 mm <sup>2</sup> / 25 mm <sup>2</sup> - 70 mm <sup>2</sup>
Screw connection	6 - 1/0 AWG / 3 - 1/0 AWG
Nominal voltage U <sub>N</sub>	1000 V
UL rated voltage	600 V
UL nominal current	150 A
Tightening torque	6 Nm - 8 Nm
Width	20 mm
Length	70.5 mm
Height NS 35/15	83.5 mm
Number of connections	2
Insulation material / Flammability rating in accordance with UL 94	PA / V0

Color	Type	Item No.	Pcs./Pkt.
dark gray	TB 50 I	3247180	10
blue	TB 50 I BU	3247187	10

Accessories	Type	Item No.	Pcs./Pkt.
Pick-off terminal block, dark gray, 0.5 - 10 mm <sup>2</sup> , snap-on, for connection of smaller cross-sections	TBT 10-TB 50/70	3251209	10
Screw bridge, 2-position, silver, with insulating collar	SCBI 2-20 N	3247222	10
Screw bridge, 3-position, silver, with insulating collar	SCBI 3-20 N	3247229	10
Screwdriver	SZS 1,2X8,0 VDE	1205082	10

Feed-through terminal block, 16 - 95 mm<sup>2</sup>, 192 A, width 20.3 mm

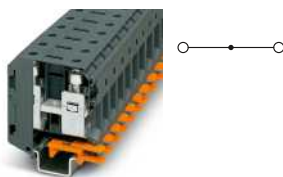

Common technical data	
Connection cross section, rigid / flexible	16 mm <sup>2</sup> - 95 mm <sup>2</sup> / 25 mm <sup>2</sup> - 70 mm <sup>2</sup>
Screw connection	4 - 3/0 AWG / 3 - 2/0 AWG
Nominal voltage U <sub>N</sub>	1000 V
UL rated voltage	1000 V
UL nominal current	192 A
Tightening torque	8 Nm - 10 Nm
Width	20.3 mm
Length	70.5 mm
Height NS 35/15	87.5 mm
Number of connections	2
Insulation material / Flammability rating in accordance with UL 94	PA / V0

Color	Type	Item No.	Pcs./Pkt.
dark gray	TB 70 I	3247194	10
blue	TB 70 I BU	3247201	10

Accessories	Type	Item No.	Pcs./Pkt.
Pick-off terminal block, dark gray, 0.5 - 10 mm <sup>2</sup> , snap-on, for connection of smaller cross-sections	TBT 10-TB 50/70	3251209	10
Screw bridge, 2-position, silver, with insulating collar	SCBI 2-20 N	3247222	10
Screw bridge, 3-position, silver, with insulating collar	SCBI 3-20 N	3247229	10
T-handle screwdriver, for Allen screws, hexagonal (with chamfer), size: hex 6 x 200 mm, ergonomically shaped handle, matt chrome-plated	SF-THEX 6-200	1212642	5

Feed-through terminal block, 25 - 95 mm<sup>2</sup>, 232 A, width 25 mm

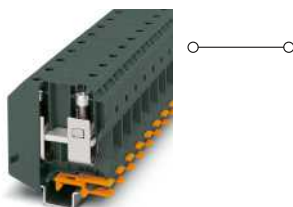

Common technical data	
Connection cross section, Level 1 above 1 below 1, rigid / flexible	25 mm <sup>2</sup> - 95 mm <sup>2</sup> / 35 mm <sup>2</sup> - 95 mm <sup>2</sup>
Screw connection	4 - 4/0 AWG / 2 - 3/0 AWG
Nominal voltage U <sub>N</sub>	1000 V
Tightening torque	15 Nm - 20 Nm
Width	25 mm
Length	82.8 mm
Height NS 35/15	97.6 mm
Number of connections	2
Insulation material / Flammability rating in accordance with UL 94	PA / V0

Color	Type	Item No.	Pcs./Pkt.
dark gray	TB 95 I	3251200	3
blue	TB 95 I BU	3251203	3

Accessories	Type	Item No.	Pcs./Pkt.
Pick-off terminal block, dark gray, 0.5 - 10 mm <sup>2</sup> , snap-on, for connection of smaller cross-sections	TBT 10-TB 95	3251210	10
Insertion bridge, 2-position, gray, Bridging in the terminal point	INB 2-25	3251212	10
Insertion bridge, 3-position, gray, Bridging in the terminal point	INB 3-25	3251213	10
T-handle screwdriver, for Allen screws, hexagonal (with chamfer), size: hex 6 x 200 mm, ergonomically shaped handle, matt chrome-plated	SF-THEX 6-200	1212642	5
Labeled terminal marker, Mounting type: adhesive	WS-4K	1004584	10

Protective conductor terminal, 0.5 - 4 mm<sup>2</sup>, width 5.2 mm

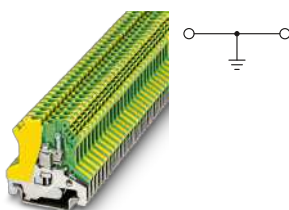

Technical data	
Connection cross section, Level 1 above 1 below 1, rigid / flexible	0.5 mm <sup>2</sup> - 4 mm <sup>2</sup> / 0.5 mm <sup>2</sup> - 2.5 mm <sup>2</sup>
Screw connection	20 - 12 AWG / 20 - 14 AWG
Tightening torque	0.4 Nm - 0.5 Nm
Width	5.2 mm
Length	42.5 mm
Height NS 35/7,5	42 mm
Number of connections	2
Insulation material / Flammability rating in accordance with UL 94	PA / V0
Color	green-yellow

Type	Item No.	Pcs./Pkt.
TB 2,5-PE I	3059841	50

Accessories	Type	Item No.	Pcs./Pkt.
Screwdriver	SZS 0,6X3,5 VDE	1212602	10

# Terminal blocks

## TB screw connection terminal blocks

### Protective conductor terminal, 0.5 - 6 mm<sup>2</sup>, width 6.2 mm

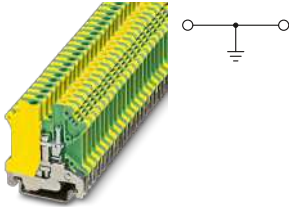

Technical data	
Connection cross section, Level 1 above 1 below 1, rigid / flexible	0.5 mm <sup>2</sup> - 6 mm <sup>2</sup> / 0.5 mm <sup>2</sup> - 4 mm <sup>2</sup>
Screw connection	20 - 10 AWG / 20 - 12 AWG
Tightening torque	0.5 Nm - 0.6 Nm
Width	6.2 mm
Length	42.5 mm
Height NS 35/7,5	47 mm
Number of connections	2
Insulation material / Flammability rating in accordance with UL 94	PA / V0
Color	green-yellow

Type	Item No.	Pcs./Pkt.
TB 4-PE I	3059980	50

Accessories	Type	Item No.	Pcs./Pkt.
Screwdriver	SZS 0,6X3,5 VDE	1212602	10

### Protective conductor terminal, 0.2 - 10 mm<sup>2</sup>, width 8.2 mm

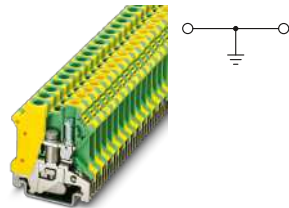

Technical data	
Connection cross section, Level 1 above 1 below 1, rigid / flexible	0.2 mm <sup>2</sup> - 10 mm <sup>2</sup> / 0.2 mm <sup>2</sup> - 6 mm <sup>2</sup>
Screw connection	24 - 8 AWG / 24 - 10 AWG
Tightening torque	1.5 Nm - 1.8 Nm
Width	8.2 mm
Length	42.5 mm
Height NS 35/7,5	47 mm
Number of connections	2
Insulation material / Flammability rating in accordance with UL 94	PA / V0
Color	green-yellow

Type	Item No.	Pcs./Pkt.
TB 6-PE I	3059870	50

Accessories	Type	Item No.	Pcs./Pkt.
Screwdriver	SZS 1,0X4,0 VDE	1205066	10

### Protective conductor terminal, 0.5 - 16 mm<sup>2</sup>, width 10.2 mm

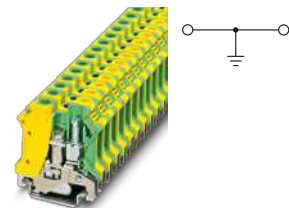

Technical data	
Connection cross section, Level 1 above 1 below 1, rigid / flexible	0.5 mm <sup>2</sup> - 16 mm <sup>2</sup> / 0.5 mm <sup>2</sup> - 10 mm <sup>2</sup>
Screw connection	20 - 6 AWG / 20 - 8 AWG
Tightening torque	1.5 Nm - 1.8 Nm
Width	10.2 mm
Length	42.5 mm
Height NS 35/7,5	47 mm
Number of connections	2
Insulation material / Flammability rating in accordance with UL 94	PA / V0
Color	green-yellow

Type	Item No.	Pcs./Pkt.
TB 10-PE I	3059883	50

Accessories	Type	Item No.	Pcs./Pkt.
Screwdriver	SZS 1,0X4,0 VDE	1205066	10

### Ground modular terminal block, 6 - 16 mm<sup>2</sup>, width 12.2 mm

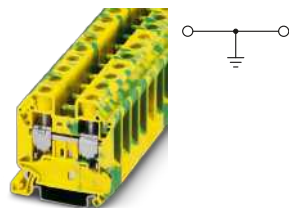

Technical data	
Connection cross section, Level 1 above 1 below 1, rigid / flexible	6 mm <sup>2</sup> - 16 mm <sup>2</sup> / 6 mm <sup>2</sup> - 16 mm <sup>2</sup>
Screw connection	10 - 6 AWG / 10 - 6 AWG
Tightening torque	2.5 Nm - 3 Nm
Width	12.2 mm
Length	42.5 mm
Height NS 35/7,5	50.5 mm
Number of connections	2
Insulation material / Flammability rating in accordance with UL 94	PA / V2
Color	green-yellow

Type	Item No.	Pcs./Pkt.
TB 16-PE EI	5792174	50

Ground modular terminal block, 10 - 35 mm<sup>2</sup>, width 15.2 mm



Technical data	
Connection cross section, Level 1 above 1 below 1, rigid / flexible	10 mm <sup>2</sup> - 35 mm <sup>2</sup> / 10 mm <sup>2</sup> - 35 mm <sup>2</sup>
Screw connection	10 - 2 AWG / 10 - 2 AWG
Tightening torque	3 Nm - 3.5 Nm
Width	15.2 mm
Length	54.4 mm
Height NS 35/7,5	62.1 mm
Number of connections	2
Insulation material / Flammability rating in accordance with UL 94	PA / V2
Color	green-yellow

Type	Item No.	Pcs./Pkt.
TB 35-PE EI	5792175	50

Feed-through terminal block, 0.5 - 2.5 mm<sup>2</sup>, 24 A, 3 Connections, width 5.2 mm

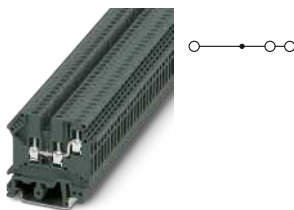

Technical data	
Connection cross section, Level 1 above 1+2 below 1, rigid / flexible	0.5 mm <sup>2</sup> - 2.5 mm <sup>2</sup> / 0.5 mm <sup>2</sup> - 4 mm <sup>2</sup>
Screw connection	20 - 12 AWG / 20 - 12 AWG
Nominal voltage U <sub>N</sub>	400 V (in the case of enclosed clamping space)
UL rated voltage	300 V
UL nominal current	10 A
Tightening torque	0.4 Nm - 0.5 Nm
Width	5.2 mm
Length	50.5 mm
Height NS 35/7,5	47 mm
Number of connections	3
Insulation material / Flammability rating in accordance with UL 94	PA / V2
Color	dark gray

Type	Item No.	Pcs./Pkt.
TB 2,5-TWIN EI	3214178	1

Feed-through terminal block, 0.5 - 4 mm<sup>2</sup>, 32 A, 3 Connections, width 6.2 mm

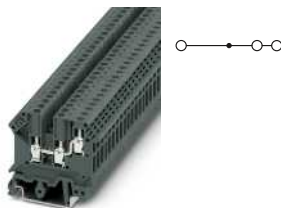

Technical data	
Connection cross section, Level 1 above 1+2 below 1, rigid / flexible	0.5 mm <sup>2</sup> - 4 mm <sup>2</sup> / 0.5 mm <sup>2</sup> - 4 mm <sup>2</sup>
Screw connection	20 - 12 AWG / 20 - 12 AWG
Nominal voltage U <sub>N</sub>	500 V
UL rated voltage	600 V
UL nominal current	20 A
Tightening torque	0.5 Nm - 0.6 Nm
Width	6.2 mm
Length	50.5 mm
Height NS 35/7,5	47 mm
Number of connections	3
Insulation material / Flammability rating in accordance with UL 94	PA / V2
Color	dark gray

Type	Item No.	Pcs./Pkt.
TB 4-TWIN EI	3214194	50

Feed-through terminal block, 0.5 - 4 mm<sup>2</sup>, 24 A, 4 Connections, width 5.2 mm

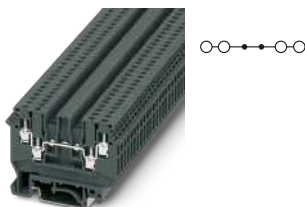

Technical data	
Connection cross section, Level 1 above 1+2 below 1+2, rigid / flexible	0.5 mm <sup>2</sup> - 4 mm <sup>2</sup> / 0.5 mm <sup>2</sup> - 2.5 mm <sup>2</sup>
Screw connection	20 - 12 AWG / 20 - 14 AWG
Nominal voltage U <sub>N</sub>	500 V
UL rated voltage	300 V
UL nominal current	20 A
Tightening torque	0.4 Nm - 0.5 Nm
Width	5.2 mm
Length	63.5 mm
Height NS 35/7,5	47 mm
Number of connections	4
Insulation material / Flammability rating in accordance with UL 94	PA / V2
Color	dark gray

Type	Item No.	Pcs./Pkt.
TB 2,5-QUATTRO EI	3214181	1

# Terminal blocks

## TB screw connection terminal blocks

### Feed-through terminal block, 0.5 - 6 mm<sup>2</sup>, 32 A, 4 Connections, width 6.2 mm

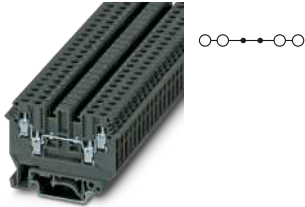

Technical data	
Connection cross section, Level 1 above 1+2 below 1+2, rigid / flexible	0.5 mm <sup>2</sup> - 6 mm <sup>2</sup> / 0.5 mm <sup>2</sup> - 4 mm <sup>2</sup>
Screw connection	20 - 10 AWG / 20 - 12 AWG
Nominal voltage U <sub>N</sub>	630 V
UL rated voltage	600 V
UL nominal current	30 A
Tightening torque	0.5 Nm - 0.6 Nm
Width	6.2 mm
Length	63.5 mm
Height NS 35/7,5	47 mm
Number of connections	4
Insulation material / Flammability rating in accordance with UL 94	PA / V2
Color	dark gray

Type	Item No.	Pcs./Pkt.
TB 4-QUATTRO EI	3214204	1

### Double-level terminal block, 0.5 - 4 mm<sup>2</sup>, 24 A, 2 Levels, width 5.2 mm

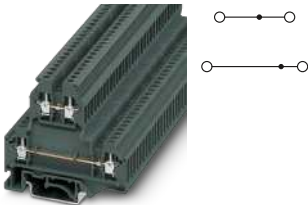

Technical data	
Connection cross section, Level 1+2 above 1 below 1, rigid / flexible	0.5 mm <sup>2</sup> - 4 mm <sup>2</sup> / 0.5 mm <sup>2</sup> - 2.5 mm <sup>2</sup>
Screw connection	20 - 12 AWG / 20 - 14 AWG
Nominal voltage U <sub>N</sub>	500 V (in the case of enclosed clamping space)
UL rated voltage	600 V
UL nominal current	20 A
Tightening torque	0.4 Nm - 0.5 Nm
Width	5.2 mm
Length	67 mm
Height NS 35/7,5	62.1 mm
Number of connections	4
Insulation material / Flammability rating in accordance with UL 94	PA / V2
Color	dark gray

Type	Item No.	Pcs./Pkt.
TB 2,5-2L EI	3214217	50

### Double-level terminal block, 0.5 - 6 mm<sup>2</sup>, 32 A, 2 Levels, width 6.2 mm

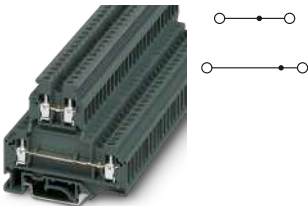

Technical data	
Connection cross section, Level 1+2 above 1 below 1, rigid / flexible	0.5 mm <sup>2</sup> - 6 mm <sup>2</sup> / 0.5 mm <sup>2</sup> - 4 mm <sup>2</sup>
Screw connection	20 - 10 AWG / 20 - 12 AWG
Nominal voltage U <sub>N</sub>	500 V (in the case of enclosed clamping space)
UL rated voltage	600 V
UL nominal current	30 A
Tightening torque	0.5 Nm - 0.6 Nm
Width	6.2 mm
Length	67 mm
Height NS 35/7,5	62 mm
Number of connections	4
Insulation material / Flammability rating in accordance with UL 94	PA / V2
Color	dark gray

Type	Item No.	Pcs./Pkt.
TB 4-2L EI	3214233	50

### Fuse modular terminal block, G / 5 x 20, 0.5 - 6 mm<sup>2</sup>, 6.3 A, 1 Levels, width 8.2 mm

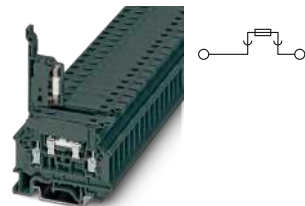

Common technical data	
Connection cross section, Level 1 above 1 below 1, rigid / flexible	0.5 mm <sup>2</sup> - 6 mm <sup>2</sup> / 0.5 mm <sup>2</sup> - 4 mm <sup>2</sup>
Screw connection	20 - 10 AWG / 20 - 12 AWG
Tightening torque	0.5 Nm - 0.6 Nm
Width	8.2 mm
Length	58 mm
Number of connections	2

Nominal voltage U <sub>N</sub>	Height NS 35/7,5	Insulation material / Flammability rating in accordance with UL 94	Color	Type	Item No.	Pcs./Pkt.
500 V (the voltage is determined by the fuse used)	50 mm	PA / V2	dark gray	TB 4-HESI (5X20) EI	3075773	1
500 V (the voltage is determined by the light indicator.)	48 mm	PA / V0	blue	TB 4-HESI (5X20) I BU	3246419	50



Fuse modular terminal block, G / 5 x 20, 0.5 - 6 mm<sup>2</sup>, 6.3 A, 1 Levels, width 8.2 mm

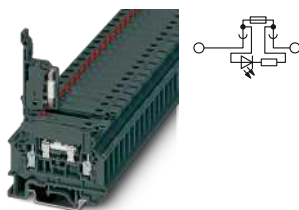

Common technical data

Connection cross section, Level 1 above 1 below 1, rigid / flexible	0.5 mm <sup>2</sup> - 6 mm <sup>2</sup> / 0.5 mm <sup>2</sup> - 4 mm <sup>2</sup>
Screw connection	20 - 10 AWG / 20 - 12 AWG
Tightening torque	0.5 Nm - 0.6 Nm
Width	8.2 mm
Length	58 mm
Height NS 35/7,5	50 mm
Number of connections	2
Insulation material / Flammability rating in accordance with UL 94	PA / V2
Color	dark gray

Nominal voltage U <sub>N</sub>	UL rated voltage	UL nominal current	Type	Item No.	Pcs./Pkt.
24 V	-	-	TB 4-HESILED 24 (5X20) EI	3075799	1
60 V	-	-	TB 4-HESILED 60 (5X20) EI	3075809	50
500 V (the voltage is determined by the fuse used)	600 V	6.3 A	TB 4-HESILA 250 (5X20) EI	3075812	1

Lever-type disconnect terminal block, 0.5 - 6 mm<sup>2</sup>, 16 A, width 8.2 mm

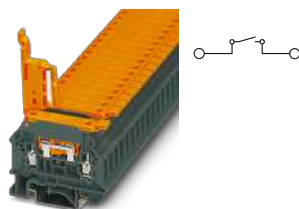

Technical data

Connection cross section, Level 1 above 1 below 1, rigid / flexible	0.5 mm <sup>2</sup> - 6 mm <sup>2</sup> / 0.5 mm <sup>2</sup> - 4 mm <sup>2</sup>
Screw connection	20 - 10 AWG / 20 - 12 AWG
Nominal voltage U <sub>N</sub>	600 V
Tightening torque	0.5 Nm - 0.6 Nm
Width	8.2 mm
Length	58 mm
Height NS 35/7,5	46.8 mm
Number of connections	2
Insulation material / Flammability rating in accordance with UL 94	PA / V2
Color	dark gray/orange

Type	Item No.	Pcs./Pkt.
TB 4-HEDI EI	3075786	1

Fuse modular terminal block, G / 5 x 20, 0.5 - 6 mm<sup>2</sup>, 41 A, width 8.2 mm



Technical data

Connection cross section, rigid / flexible	0.5 mm <sup>2</sup> - 6 mm <sup>2</sup> / 0.5 mm <sup>2</sup> - 4 mm <sup>2</sup>
Screw connection	20 - 10 AWG / 20 - 12 AWG
Nominal voltage U <sub>N</sub>	800 V
Width	8.2 mm
Length	86.6 mm
Height NS 35/7,5	71.2 mm
Insulation material / Flammability rating in accordance with UL 94	PA / V0

Type	Item No.	Pcs./Pkt.
TB 4-L-HESI(5X20) EI	1061945	1

Disconnect terminal block, 0.5 - 6 mm<sup>2</sup>, 16 A, width 6.15 mm

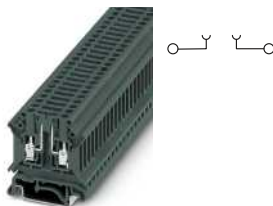

Common technical data

Connection cross section, Level 1 above 1 below 1, rigid / flexible	0.5 mm <sup>2</sup> - 6 mm <sup>2</sup> / 0.5 mm <sup>2</sup> - 4 mm <sup>2</sup>
Screw connection	20 - 10 AWG / 20 - 12 AWG
UL rated voltage	600 V
UL nominal current	15 A
Tightening torque	0.5 Nm - 0.6 Nm
Width	6.15 mm
Length	42.5 mm
Height NS 35/7,5	47 mm
Number of connections	2
Insulation material / Flammability rating in accordance with UL 94	PA / V2
Color	dark gray

Nominal voltage U <sub>N</sub>	Type	Item No.	Pcs./Pkt.
800 V	TB 4-TG EI	3075757	50
500 V (is determined based on the type of plug used)	TB 4-TG-P/P EI	3059294	1

## Terminal blocks

### TB screw connection terminal blocks

#### Knife-disconnect terminal block, 0.5 - 6 mm<sup>2</sup>, 16 A, width 6.15 mm

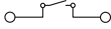

##### Common technical data

Connection cross section, Level 1 above 1 below 1, rigid / flexible	0.5 mm <sup>2</sup> - 6 mm <sup>2</sup> / 0.5 mm <sup>2</sup> - 4 mm <sup>2</sup>
Screw connection	20 - 10 AWG / 20 - 12 AWG
Nominal voltage U <sub>N</sub>	800 V (Rated surge voltage = 6 kV)
UL rated voltage	600 V
UL nominal current	15 A
Tightening torque	0.5 Nm - 0.6 Nm
Width	6.15 mm
Length	42.5 mm
Height NS 35/7,5	59.8 mm
Number of connections	2
Insulation material / Flammability rating in accordance with UL 94	PA / V2
Color	dark gray/orange

Type	Item No.	Pcs./Pkt.
TB 4-MT EI	3075744	1
TB 4-MT-P/P EI	3059304	50

#### Disconnect terminal block, 1.5 - 6 mm<sup>2</sup>, 41 A, width 8.2 mm



##### Technical data

Connection cross section, Level 1 above 1 below 1, rigid / flexible	1.5 mm <sup>2</sup> - 6 mm <sup>2</sup> / 1.5 mm <sup>2</sup> - 6 mm <sup>2</sup>
Screw connection	16 - 8 AWG / 16 - 10 AWG
Nominal voltage U <sub>N</sub>	800 V (in the case of enclosed clamping space)
UL rated voltage	600 V
UL nominal current	30 A
Tightening torque	1.4 Nm - 1.5 Nm
Width	8.2 mm
Length	66.5 mm
Height NS 35/7,5	48 mm
Number of connections	2
Insulation material / Flammability rating in accordance with UL 94	PA / V2
Color	dark gray

Type	Item No.	Pcs./Pkt.
TB 6-T EI	3075838	50

#### Feed-through terminal block, 1.5 - 6 mm<sup>2</sup>, 41 A, width 8.2 mm



##### Technical data

Connection cross section, Level 1 above 1 below 1, rigid / flexible	1.5 mm <sup>2</sup> - 6 mm <sup>2</sup> / 1.5 mm <sup>2</sup> - 6 mm <sup>2</sup>
Screw connection	16 - 8 AWG / 16 - 10 AWG
Nominal voltage U <sub>N</sub>	800 V (in the case of enclosed clamping space)
UL rated voltage	600 V
UL nominal current	30 A
Tightening torque	1.4 Nm - 1.5 Nm
Width	8.2 mm
Length	66.5 mm
Height NS 35/7,5	48 mm
Number of connections	2
Insulation material / Flammability rating in accordance with UL 94	PA / V2
Color	dark gray

Type	Item No.	Pcs./Pkt.
TBD 6 EI	3075854	50

**Bolt connection terminal block, 41 A, width 9.1 mm**

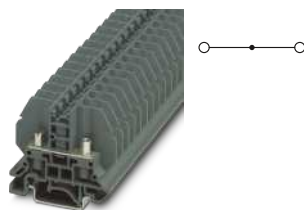

Technical data	
Nominal voltage U <sub>N</sub>	800 V
UL rated voltage	600 V
UL nominal current	30 A
Width	9.1 mm
Length	53.6 mm
Height NS 35/7,5	47.2 mm
Number of connections	2
Insulation material / Flammability rating in accordance with UL 94	PA / V0
Color	dark gray

Type	Item No.	Pcs./Pkt.
RBO 3 SP/SP	1159238	1

**Bolt connection terminal block, 57 A, width 13 mm**

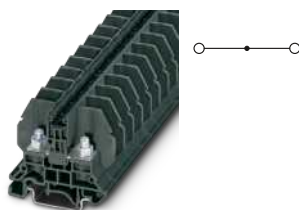

Common technical data	
Nominal voltage U <sub>N</sub>	800 V
UL rated voltage	600 V
UL nominal current	45 A
Length	53.3 mm
Number of connections	2
Insulation material / Flammability rating in accordance with UL 94	PA / V2
Color	dark gray

Width	Height NS 35/7,5	Type	Item No.	Pcs./Pkt.
13 mm	47.1 mm	RBO 5 E	3059540	50
20.75 mm	37 mm	RBO 5-F E	3059582	50

Accessories		Type	Item No.	Pcs./Pkt.
End cover, width 2.2 mm, dark gray		D-RSC 5 E	3059618	50
End cover, width 2.2 mm, dark gray		D-RSC 5-F E	3059676	50
Fixed bridge, 10-position, silver		FB 10-13	3059126	10
Fixed bridge, 10-position, silver		FB 10-13 ISO	3059663	10
CCT for this product type is not defined / Cover profile / 3058017		AP RSC	3058017	10

**Bolt connection terminal block, 57 A, width 13 mm**

With reduced-size connection screw

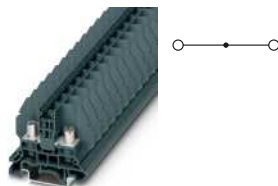

Technical data	
Nominal voltage U <sub>N</sub>	800 V
UL rated voltage	600 V
UL nominal current	45 A
Width	13 mm
Length	53.3 mm
Height NS 35/7,5	47.1 mm
Number of connections	2
Insulation material / Flammability rating in accordance with UL 94	PA / V2
Color	gray

Type	Item No.	Pcs./Pkt.
RBO 5 SP/SP E	3000896	50

Accessories		Type	Item No.	Pcs./Pkt.
End cover, width 2.2 mm, dark gray		D-RSC 5 E	3059618	50
Fixed bridge, 10-position, silver		FB 10-13	3059126	10
Fixed bridge, 10-position, silver		FB 10-13 ISO	3059663	10
CCT for this product type is not defined / Cover profile / 3058017		AP RSC	3058017	10

# Terminal blocks

## BC screw connecting plug

### Bolt connection terminal block, 125 A, width 17 mm

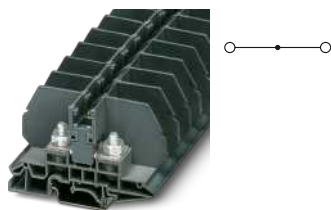

Common technical data	
Nominal voltage $U_N$	800 V
UL rated voltage	600 V
UL nominal current	115 A
Width	17 mm
Length	80.8 mm
Number of connections	2
Insulation material / Flammability rating in accordance with UL 94	PA / V2
Color	dark gray

Height NS 35/7,5	Type	Item No.	Pcs./Pkt.
49.8 mm	RBO 6 E	3075906	50
39.7 mm	RBO 6-F E	3075948	50

Accessories	Type	Item No.	Pcs./Pkt.
End cover, width 2.2 mm, dark gray	D-RSC 6 E	3214013	50
End cover, width 2.2 mm, dark gray	D-RSC 6-F E	3214026	50
Fixed bridge, 10-position, silver	FB 10-17	3075951	10
Fixed bridge, 10-position, silver	FB 10-17 ISO	3213085	10
CCT for this product type is not defined / Cover profile / 3059139	AP RSC-T	3059139	10

### Test disconnect terminal block, 50 A, width 13 mm

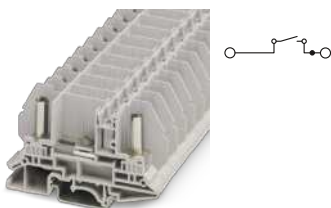

Common technical data	
Nominal voltage $U_N$	800 V
UL rated voltage	600 V
UL nominal current	45 A
Length	79.9 mm
Number of connections	2
Insulation material / Flammability rating in accordance with UL 94	PA / V2
Color	dark gray

Width	Height NS 35/7,5	Type	Item No.	Pcs./Pkt.
13 mm	47.1 mm	RBO 5-T E	3059553	50
20.75 mm	39.7 mm	RBO 5-T-F E	3059595	50

Accessories	Type	Item No.	Pcs./Pkt.
End cover, width 2.2 mm, dark gray	D-RSC 5-T E	3059621	50
End cover, width 2.2 mm, dark gray	D-RSC 5-T-F E	3059634	50
Fixed bridge, 10-position, silver	FB 10-13	3059126	10
Fixed bridge, 10-position, silver	FB 10-13 ISO	3059663	10
CCT for this product type is not defined / Cover profile / 3059139	AP RSC-T	3059139	10

### Bolt connection terminal block, 32 A, width 9 mm

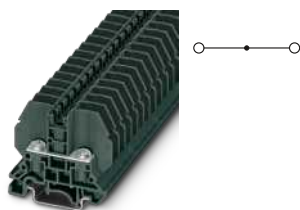

Common technical data	
Nominal voltage $U_N$	800 V
UL rated voltage	600 V
UL nominal current	30 A
Length	53.3 mm
Number of connections	2
Insulation material / Flammability rating in accordance with UL 94	PA / V2
Color	dark gray

Width	Height NS 35/7,5	Type	Item No.	Pcs./Pkt.
9 mm	47.1 mm	RSC 4 E	3059511	50
16.8 mm	37 mm	RSC 4-F E	3059605	50

Accessories	Type	Item No.	Pcs./Pkt.
End cover, width 2.2 mm, dark gray	D-RSC 5 E	3059618	50
Fixed bridge, 10-position, silver	FB 10-9	3059113	10
Fixed bridge, 10-position, silver	FB 10-9 ISO	3059650	10
CCT for this product type is not defined / Cover profile / 3058017	AP RSC	3058017	10

### Bolt connection terminal block, 32 A, width 9 mm

With reduced-size connection screw

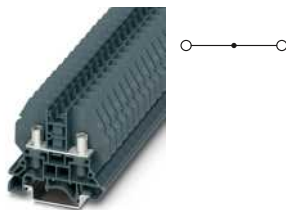

Technical data	
Nominal voltage $U_N$	800 V
UL rated voltage	600 V
UL nominal current	30 A
Width	9 mm
Length	53.3 mm
Height NS 35/7,5	47.1 mm
Number of connections	2
Insulation material / Flammability rating in accordance with UL 94	PA / V2
Color	gray

Type	Item No.	Pcs./Pkt.
RSC 4 SP/SP E	3000891	50

Accessories		Type	Item No.	Pcs./Pkt.
End cover, width 2.2 mm, dark gray		D-RSC 5 E	3059618	50
Fixed bridge, 10-position, silver		FB 10-9	3059113	10
Fixed bridge, 10-position, silver		FB 10-9 ISO	3059650	10
CCT for this product type is not defined / Cover profile / 3058017		AP RSC	3058017	10

### Bolt connection terminal block, 57 A, width 13 mm

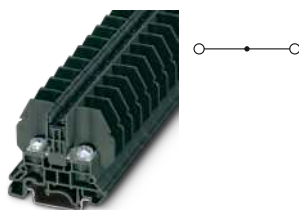

Common technical data	
Nominal voltage $U_N$	800 V
UL rated voltage	600 V
UL nominal current	45 A
Length	53.3 mm
Number of connections	2
Insulation material / Flammability rating in accordance with UL 94	PA / V2
Color	dark gray

Width	Height NS 35/7,5	Type	Item No.	Pcs./Pkt.
13 mm	47.1 mm	RSC 5 E	3059524	50
20.8 mm	37 mm	RSC 5-F E	3059566	50

Accessories		Type	Item No.	Pcs./Pkt.
End cover, width 2.2 mm, dark gray		D-RSC 5 E	3059618	50
End cover, width 2.2 mm, dark gray		D-RSC 5-F E	3059676	50
Fixed bridge, 10-position, silver		FB 10-9	3059113	10
Fixed bridge, 10-position, silver		FB 10-9 ISO	3059650	10
CCT for this product type is not defined / Cover profile / 3058017		AP RSC	3058017	10

### Bolt connection terminal block, 57 A, width 13 mm

With reduced-size connection screw

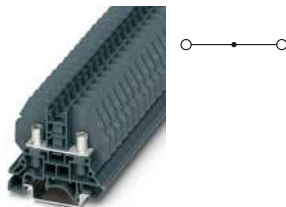

Technical data	
Nominal voltage $U_N$	800 V
UL rated voltage	600 V
UL nominal current	45 A
Width	13 mm
Length	53.3 mm
Height NS 35/7,5	47.1 mm
Number of connections	2
Insulation material / Flammability rating in accordance with UL 94	PA / V2
Color	dark gray

Type	Item No.	Pcs./Pkt.
RSC 5 SP/SP E	3000892	50

Accessories		Type	Item No.	Pcs./Pkt.
End cover, width 2.2 mm, dark gray		D-RSC 5 E	3059618	50
Fixed bridge, 10-position, silver		FB 10-13	3059126	10
Fixed bridge, 10-position, silver		FB 10-13 ISO	3059663	10
CCT for this product type is not defined / Cover profile / 3058017		AP RSC	3058017	10

# Terminal blocks

## BC screw connecting plug

### Test disconnect terminal block, 50 A, width 13 mm

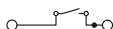

Common technical data	
UL rated voltage	600 V
UL nominal current	45 A
Length	79.9 mm
Number of connections	2
Insulation material / Flammability rating in accordance with UL 94	PA / V2
Color	dark gray

Nominal voltage U <sub>N</sub>	Width	Height NS 35/7,5	Type	Item No.	Pcs./Pkt.
500 V	13 mm	49.8 mm	RSC 5-T E	3059537	50
800 V	20.75 mm	39.7 mm	RSC 5-T-F E	3059579	50

Accessories		Type	Item No.	Pcs./Pkt.
End cover, width 2.2 mm, dark gray		D-RSC 5-T E	3059621	50
End cover, width 2.2 mm, dark gray		D-RSC 5-T-F E	3059634	50
Fixed bridge, 10-position, silver		FB 10-13	3059126	10
Fixed bridge, 10-position, silver		FB 10-13 ISO	3059663	10
CCT for this product type is not defined / Cover profile / 3059139		AP RSC-T	3059139	10

### Bolt connection terminal block, 125 A, width 17 mm



Common technical data	
Nominal voltage U <sub>N</sub>	800 V
UL rated voltage	600 V
UL nominal current	115 A
Width	17 mm
Length	80.8 mm
Number of connections	2
Insulation material / Flammability rating in accordance with UL 94	PA / V2
Color	dark gray

Height NS 35/7,5	Type	Item No.	Pcs./Pkt.
49.8 mm	RSC 6 E	3075883	50
39.7 mm	RSC 6-F E	3075922	50

Accessories		Type	Item No.	Pcs./Pkt.
End cover, width 2.2 mm, dark gray		D-RSC 6 E	3214013	50
End cover, width 2.2 mm, dark gray		D-RSC 6-F E	3214026	50
Fixed bridge, 10-position, silver		FB 10-17	3075951	10
Fixed bridge, 10-position, silver		FB 10-17 ISO	3213085	10
CCT for this product type is not defined / Cover profile / 3059139		AP RSC-T	3059139	10





# Surge protection



## Surge protection

Lightning currents and surge voltages may cause damage to devices and components. In the worst case, the entire system may even fail. Downtimes and repairs further lead to high costs. Businesses in every industry require a high degree of system availability. With individualized solutions for requirements in a wide variety of applications, reliable surge protection by Phoenix Contact makes a significant contribution.

## Product range overview

---

Surge protection for the power supply

**38**

---

**Powerful and durable**



The surge protective devices are subjected to a large number of tests and examinations during their development phase in the in-house, certified pulse and high-current laboratory. A special feature of this laboratory is a powerful power supply system that can be coupled with a surge current generator. Thus, an environment is created in which surge protective devices can be tested intensively under challenging conditions.



**Basic research**

The foundation for a high-quality product is basic research and technological development. New technologies and materials for surge protection are developed and made usable with specific targets in mind.



**Development and production**

In a dialog between development and production, components and materials are harmonized to create a robust, reliable and powerful product. It is ensured that the high requirements on a reliable and effective protective device are satisfied at all times.



**Quality tests**

Standardized quality tests are performed throughout production and thus guarantee products of the highest levels of quality and safety.



### Combined protective devices, type 1+2

SP-EE-FLT is suitable for universal use in TN and TT networks and meets the requirements of lightning protection levels III and IV. The encapsulated spark gap, which is free of leakage current and line follow current, limits lightning-related voltage peaks and switching overvoltages to the level of over-voltage category II. It can therefore be used in the unmetred area.



### Lightning current arresters / surge protective devices, type 1/2

The VAL-MS-EE-T1/T2 varistor-based lightning current arresters meet the requirements of lightning protection levels III and IV and also provide the voltage protection level of a type 2 surge protective device.



### Surge protective devices, type 2

The devices are usually installed in subdistributions or control cabinets. These devices must be able to discharge induced surge voltages from direct lightning strikes or switching operations, but do not have to handle direct lightning currents. In any case, induced surge voltages caused by switching operations are very dynamic and fast response behavior is required.



### Availability

Surge protection by Phoenix Contact plays a major role in assuring a high level of system availability in the widest range of applications.



### Device protection, type 3

The surge protective devices are generally installed immediately upstream of the end devices to be protected. PLT-EE provides optimal protection for single-phase industrial power supplies in various nominal voltage ranges.

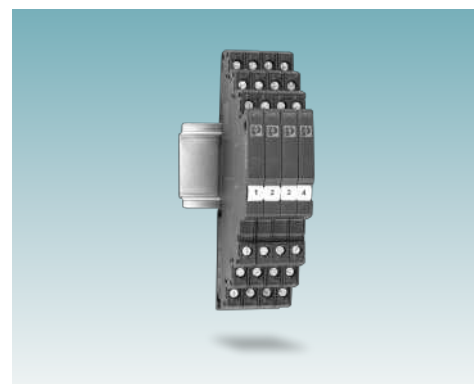

### Signal protection for MCR technology

Surge protection for measurement and control technology includes versions that can be used for many fields of application. The benefits of these devices include their proven and cost-optimized functionality as well as their compact and therefore space-saving design with a pitch of just 6 mm.

# Surge protection

## Surge protection for the power supply

### Type 1+2 combined lightning current and surge arrester, TN-C, TT, 25 kA, 1L-N/PE

Lightning arrester, in acc. with type 1 / class I, for 1-phase power supply networks with combined PE and N installed in one cable (L1, PEN).

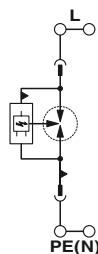

Technical data	
Nominal voltage $U_N$	240 V AC (TN-C) / 240 V AC (TT)
Mode of protection	L-N / L-PEN
Maximum continuous operating voltage $U_C$	264 V AC
Impulse discharge current $I_{imp}$ (10/350) $\mu$ s	25 kA
Nominal discharge current $I_n$ (8/20) $\mu$ s	25 kA
Max. discharge current $I_{max}$ (8/20) $\mu$ s	50 kA
Protection level $U_p$	$\leq 1.5$ kV
Follow current interrupt rating $I_{fi}$	50 kA
Short-circuit current rating $I_{SCCR}$	50 kA
Backup fuse	315 A (gG)
Dimensions W/H/D	35.8 mm / 89.8 mm / 65.8 mm
IEC connection data Rigid/flexible/AWG	10 ... 50 mm <sup>2</sup> / 16 ... 35 mm <sup>2</sup> / 6 ... 1
Temperature range	-40 °C ... 80 °C
Test standards	IEC 61643-11 / EN 61643-11

Type	Item No.	Pcs./Pkt.
FLT-EE-T1-1+0-264/25	2910495	1

### Type 1+2 combined lightning current and surge arrester, TN-C, TT, 50 kA, 1L-N/PE

Lightning arrester, in acc. with type 1 / class I, for 1-phase power supply networks with combined PE and N installed in one cable (L1, PEN).

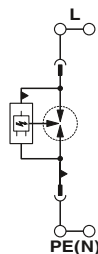

Technical data	
Nominal voltage $U_N$	240 V AC (TN-C) / 240 V AC (TT)
Mode of protection	L-N / L-PEN
Maximum continuous operating voltage $U_C$	264 V AC
Impulse discharge current $I_{imp}$ (10/350) $\mu$ s	50 kA
Nominal discharge current $I_n$ (8/20) $\mu$ s	50 kA
Max. discharge current $I_{max}$ (8/20) $\mu$ s	50 kA
Protection level $U_p$	$\leq 2.5$ kV
Follow current interrupt rating $I_{fi}$	50 kA
Short-circuit current rating $I_{SCCR}$	50 kA
Backup fuse	500 A (gG)
Dimensions W/H/D	35.8 mm / 89.8 mm / 65.8 mm
IEC connection data Rigid/flexible/AWG	10 ... 50 mm <sup>2</sup> / 16 ... 35 mm <sup>2</sup> / 6 ... 1
Temperature range	-40 °C ... 80 °C
Test standards	IEC 61643-11 / EN 61643-11

Type	Item No.	Pcs./Pkt.
FLT-EE-T1-1+0-264/50	2910496	1

### Type 1+2 combined lightning current and surge arrester, TN-S, TT, 100 kA, N-PE

Lightning arrester, in acc. with type 1 / class I, for use in power supply networks between N and PE.

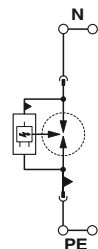

Technical data	
Nominal voltage $U_N$	240 V AC (TN - only N-PE) / 240 V AC (TT - only N-PE)
Mode of protection	N-PE
Maximum continuous operating voltage $U_C$	264 V AC
Impulse discharge current $I_{imp}$ (10/350) $\mu$ s	100 kA
Nominal discharge current $I_n$ (8/20) $\mu$ s	100 kA
Protection level $U_p$	$\leq 3$ kV
Follow current interrupt rating $I_{fi}$	100 A
Dimensions W/H/D	35.8 mm / 89.8 mm / 65.8 mm
IEC connection data Rigid/flexible/AWG	10 ... 50 mm <sup>2</sup> / 16 ... 35 mm <sup>2</sup> / 6 ... 1
Temperature range	-40 °C ... 80 °C
Test standards	IEC 61643-11 / EN 61643-11

Type	Item No.	Pcs./Pkt.
FLT-EE-T1-N/PE-264/100	2910497	1

### Type 1+2 combined lightning current and surge arrester, 12.5 kA

Universal spark gap-based non-pluggable lightning current arrester / surge protective device for 1-phase power supply networks with separate N and PE (3-conductor system: L1, N, PE), for lightning protection levels III and IV.

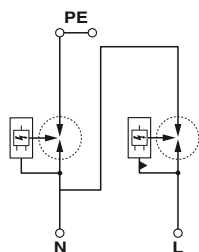

Technical data	
Nominal voltage $U_N$	240/415 V AC (TN-S) / 240/415 V AC (TT)
Mode of protection	L-N / L-PE / N-PE
Maximum continuous operating voltage $U_C$	264 V AC
Impulse discharge current $I_{imp}$ (10/350) $\mu$ s	12.5 kA / 12.5 kA / 25 kA
Nominal discharge current $I_n$ (8/20) $\mu$ s	12.5 kA / 12.5 kA / 25 kA
Max. discharge current $I_{max}$ (8/20) $\mu$ s	- / - / -
Protection level $U_p$	$\leq 1.5$ kV / $\leq 2.5$ kV / $\leq 1.5$ kV
Follow current interrupt rating $I_{fi}$	25 kA / - / 100 A
Short-circuit current rating $I_{SCCR}$	25 kA
Backup fuse	160 A (gG)
Dimensions W/H/D	36 mm / 89.8 mm / 76.6 mm
IEC connection data Rigid/flexible/AWG	2.5 ... 35 mm <sup>2</sup> / 2.5 ... 25 mm <sup>2</sup> / 13 ... 2
Temperature range	-40 °C ... 85 °C
Test standards	IEC 61643-11 / EN 61643-11

Type	Item No.	Pcs./Pkt.
SP-EE-FLT-T1-264/12.5-1+1-UT	1326687	1

### Type 1+2 combined lightning current and surge arrester, 12.5 kA, Remote indication contact

Universal spark gap-based non-pluggable lightning current arrester / surge protective device for 1-phase power supply networks with separate N and PE (3-conductor system: L1, N, PE), for lightning protection levels III and IV, with remote signaling.

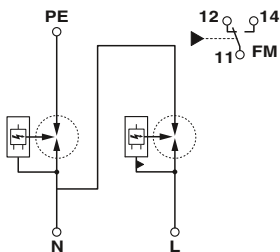

Technical data	
Nominal voltage $U_N$	240/415 V AC (TN-S) / 240/415 V AC (TT)
Mode of protection	L-N / L-PE / N-PE
Maximum continuous operating voltage $U_C$	264 V AC
Impulse discharge current $I_{imp}$ (10/350) $\mu$ s	12.5 kA / 12.5 kA / 25 kA
Nominal discharge current $I_n$ (8/20) $\mu$ s	12.5 kA / 12.5 kA / 25 kA
Max. discharge current $I_{max}$ (8/20) $\mu$ s	- / - / -
Protection level $U_p$	$\leq 1.5$ kV / $\leq 2.5$ kV / $\leq 1.5$ kV
Follow current interrupt rating $I_{fi}$	25 kA / - / 100 A
Short-circuit current rating $I_{SCCR}$	25 kA
Backup fuse	160 A (gG)
Remote indication contact	Changeover contact
Dimensions W/H/D	36 mm / 99.7 mm / 76.6 mm
IEC connection data Rigid/flexible/AWG	2.5 ... 35 mm <sup>2</sup> / 2.5 ... 25 mm <sup>2</sup> / 13 ... 2
Temperature range	-40 °C ... 85 °C
Test standards	IEC 61643-11 / EN 61643-11

Type	Item No.	Pcs./Pkt.
SP-EE-FLT-T1-264/12.5-1+1-UT-R	1326690	1

### Type 1+2 combined lightning current and surge arrester, 12.5 kA

Universal spark gap-based non-pluggable lightning current arrester / surge protective device for 3-phase power supply networks with common N and PE (4-conductor system: L1, L2, L3, PEN), for lightning protection levels III and IV.

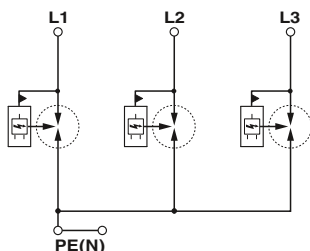

Technical data	
Nominal voltage $U_N$	240/415 V AC (TN-C)
Mode of protection	L-PEN
Maximum continuous operating voltage $U_C$	264 V AC
Impulse discharge current $I_{imp}$ (10/350) $\mu$ s	12.5 kA
Nominal discharge current $I_n$ (8/20) $\mu$ s	12.5 kA
Protection level $U_p$	$\leq 1.5$ kV
Follow current interrupt rating $I_{fi}$	25 kA
Short-circuit current rating $I_{SCCR}$	25 kA
Backup fuse	160 A (gG)
Dimensions W/H/D	72 mm / 89.8 mm / 76.6 mm
IEC connection data Rigid/flexible/AWG	2.5 ... 35 mm <sup>2</sup> / 2.5 ... 25 mm <sup>2</sup> / 13 ... 2
Temperature range	-40 °C ... 85 °C
Test standards	IEC 61643-11 / EN 61643-11

Type	Item No.	Pcs./Pkt.
SP-EE-FLT-T1-264/12.5-3+0-UT	1326692	1



# Surge protection

## Surge protection for the power supply

### Type 1+2 combined lightning current and surge arrester, 12.5 kA, Remote indication contact

Universal spark gap-based non-pluggable lightning current arrester / surge protective device for 3-phase power supply networks with common N and PE (4-conductor system: L1, L2, L3, PEN), for lightning protection levels III and IV, with remote signaling.

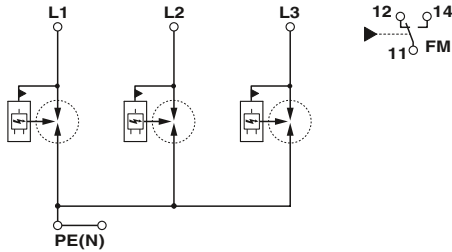

Technical data	
Nominal voltage $U_N$	240/415 V AC (TN-C)
Mode of protection	L-PEN
Maximum continuous operating voltage $U_C$	264 V AC
Impulse discharge current $I_{imp}$ (10/350) $\mu$ s	12.5 kA
Nominal discharge current $I_n$ (8/20) $\mu$ s	12.5 kA
Protection level $U_p$	$\leq 1.5$ kV
Follow current interrupt rating $I_{fi}$	25 kA
Short-circuit current rating $I_{SCCR}$	25 kA
Backup fuse	160 A (gG)
Remote indication contact	Changeover contact
Dimensions W/H/D	72 mm / 99.7 mm / 76.6 mm
IEC connection data Rigid/flexible/AWG	2.5 ... 35 mm <sup>2</sup> / 2.5 ... 25 mm <sup>2</sup> / 13 ... 2
Temperature range	-40 °C ... 85 °C
Test standards	IEC 61643-11 / EN 61643-11

Type	Item No.	Pcs./Pkt.
SP-EE-FLT-T1-264/12.5-3+0-UT-R	1326694	1

### Type 1+2 combined lightning current and surge arrester, 12.5 kA

Universal spark gap-based non-pluggable lightning current arrester / surge protective device for 3-phase power supply networks with separate N and PE (5-conductor system: L1, L2, L3, N, PE), for lightning protection levels III and IV.

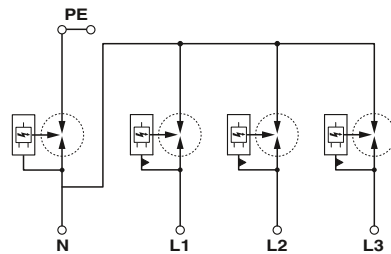

Technical data	
Nominal voltage $U_N$	240/415 V AC (TN-S) / 240/415 V AC (TT)
Mode of protection	L-N / L-PE / N-PE
Maximum continuous operating voltage $U_C$	264 V AC
Impulse discharge current $I_{imp}$ (10/350) $\mu$ s	12.5 kA / 12.5 kA / 50 kA
Nominal discharge current $I_n$ (8/20) $\mu$ s	12.5 kA / 12.5 kA / 50 kA
Max. discharge current $I_{max}$ (8/20) $\mu$ s	- / - / -
Protection level $U_p$	$\leq 1.5$ kV / $\leq 2.5$ kV / $\leq 1.5$ kV
Follow current interrupt rating $I_{fi}$	25 kA / - / 100 A
Short-circuit current rating $I_{SCCR}$	25 kA
Backup fuse	160 A (gG)
Dimensions W/H/D	72 mm / 89.8 mm / 76.6 mm
IEC connection data Rigid/flexible/AWG	2.5 ... 35 mm <sup>2</sup> / 2.5 ... 25 mm <sup>2</sup> / 13 ... 2
Temperature range	-40 °C ... 85 °C
Test standards	IEC 61643-11 / EN 61643-11

Type	Item No.	Pcs./Pkt.
SP-EE-FLT-T1-264/12.5-3+1-UT	1326696	1

### Type 1+2 combined lightning current and surge arrester, 12.5 kA, Remote indication contact

Universal spark gap-based non-pluggable lightning current arrester / surge protective device for 3-phase power supply networks with separate N and PE (5-conductor system: L1, L2, L3, N, PE), for lightning protection levels III and IV, with remote signaling.

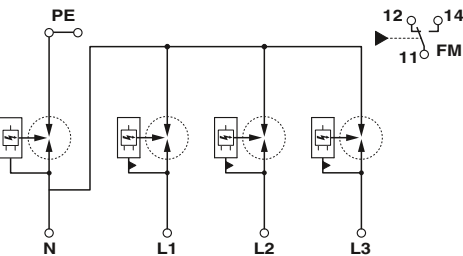

Technical data	
Nominal voltage $U_N$	240/415 V AC (TN-S) / 240/415 V AC (TT)
Mode of protection	L-N / L-PE / N-PE
Maximum continuous operating voltage $U_C$	264 V AC
Impulse discharge current $I_{imp}$ (10/350) $\mu$ s	12.5 kA / 12.5 kA / 50 kA
Nominal discharge current $I_n$ (8/20) $\mu$ s	12.5 kA / 12.5 kA / 50 kA
Max. discharge current $I_{max}$ (8/20) $\mu$ s	- / - / -
Protection level $U_p$	$\leq 1.5$ kV / $\leq 2.5$ kV / $\leq 1.5$ kV
Follow current interrupt rating $I_{fi}$	25 kA / - / 100 A
Short-circuit current rating $I_{SCCR}$	25 kA
Backup fuse	160 A (gG)
Remote indication contact	Changeover contact
Dimensions W/H/D	72 mm / 99.7 mm / 76.6 mm
IEC connection data Rigid/flexible/AWG	2.5 ... 35 mm <sup>2</sup> / 2.5 ... 25 mm <sup>2</sup> / 13 ... 2
Temperature range	-40 °C ... 85 °C
Test standards	IEC 61643-11 / EN 61643-11

Type	Item No.	Pcs./Pkt.
SP-EE-FLT-T1-264/12.5-3+1-UT-R	1326698	1

### Type 1+2 combined lightning current and surge arrester, 25 kA

High-performance, spark gap-based non-pluggable lightning current arrester / surge protective device for 1-phase power supply networks with separate N and PE (3-conductor system: L1, N, PE), for lightning protection levels I and II.

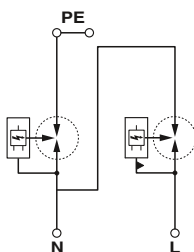

Technical data	
Nominal voltage $U_N$	240/415 V AC (TN-S) / 240/415 V AC (TT)
Mode of protection	L-N / L-PE / N-PE
Maximum continuous operating voltage $U_C$	264 V AC
Impulse discharge current $I_{imp}$ (10/350) $\mu$ s	25 kA / 25 kA / 50 kA
Nominal discharge current $I_n$ (8/20) $\mu$ s	25 kA / 25 kA / 50 kA
Max. discharge current $I_{max}$ (8/20) $\mu$ s	- / - / -
Protection level $U_p$	$\leq 1.5$ kV / $\leq 2.5$ kV / $\leq 1.5$ kV
Follow current interrupt rating $I_{fi}$	25 kA / - / 100 A
Short-circuit current rating $I_{SCCR}$	25 kA
Backup fuse	315 A (gG)
Dimensions W/H/D	36 mm / 89.8 mm / 76.6 mm
IEC connection data Rigid/flexible/AWG	2.5 ... 35 mm <sup>2</sup> / 2.5 ... 25 mm <sup>2</sup> / 13 ... 2
Temperature range	-40 °C ... 85 °C
Test standards	IEC 61643-11 / EN 61643-11

Type	Item No.	Pcs./Pkt.
SP-EE-FLT-T1-264/25-1+1-UT	1471824	1

### Type 1+2 combined lightning current and surge arrester, 25 kA, Remote indication contact

High-performance, spark gap-based non-pluggable lightning current arrester / surge protective device for 1-phase power supply networks with separate N and PE (3-conductor system: L1, N, PE), for lightning protection levels I and II, with remote signaling.

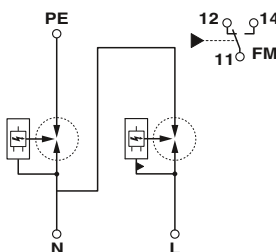

Technical data	
Nominal voltage $U_N$	240/415 V AC (TN-S) / 240/415 V AC (TT)
Mode of protection	L-N / L-PE / N-PE
Maximum continuous operating voltage $U_C$	264 V AC
Impulse discharge current $I_{imp}$ (10/350) $\mu$ s	25 kA / 25 kA / 50 kA
Nominal discharge current $I_n$ (8/20) $\mu$ s	25 kA / 25 kA / 50 kA
Max. discharge current $I_{max}$ (8/20) $\mu$ s	- / - / -
Protection level $U_p$	$\leq 1.5$ kV / $\leq 2.5$ kV / $\leq 1.5$ kV
Follow current interrupt rating $I_{fi}$	25 kA / - / 100 A
Short-circuit current rating $I_{SCCR}$	25 kA
Backup fuse	315 A (gG)
Remote indication contact	Changeover contact
Dimensions W/H/D	36 mm / 99.7 mm / 76.6 mm
IEC connection data Rigid/flexible/AWG	2.5 ... 35 mm <sup>2</sup> / 2.5 ... 25 mm <sup>2</sup> / 13 ... 2
Temperature range	-40 °C ... 85 °C
Test standards	IEC 61643-11 / EN 61643-11

Type	Item No.	Pcs./Pkt.
SP-EE-FLT-T1-264/25-1+1-UT-R	1471829	1

### Type 1+2 combined lightning current and surge arrester, 25 kA

High-performance, spark gap-based non-pluggable lightning current arrester / surge protective device for 3-phase power supply networks with separate N and PE (5-conductor system: L1, L2, L3, N, PE), for lightning protection levels I and II.

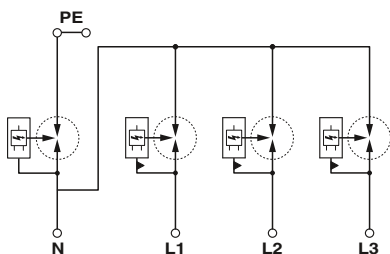

Technical data	
Nominal voltage $U_N$	240/415 V AC (TN-S) / 240/415 V AC (TT)
Mode of protection	L-N / L-PE / N-PE
Maximum continuous operating voltage $U_C$	264 V AC
Impulse discharge current $I_{imp}$ (10/350) $\mu$ s	25 kA / 25 kA / 100 kA
Nominal discharge current $I_n$ (8/20) $\mu$ s	25 kA / 25 kA / 100 kA
Max. discharge current $I_{max}$ (8/20) $\mu$ s	- / - / -
Protection level $U_p$	$\leq 1.5$ kV / $\leq 2.5$ kV / $\leq 1.5$ kV
Follow current interrupt rating $I_{fi}$	25 kA / - / 100 A
Short-circuit current rating $I_{SCCR}$	25 kA
Backup fuse	315 A (gG)
Dimensions W/H/D	72 mm / 89.8 mm / 76.6 mm
IEC connection data Rigid/flexible/AWG	2.5 ... 35 mm <sup>2</sup> / 2.5 ... 25 mm <sup>2</sup> / 13 ... 2
Temperature range	-40 °C ... 85 °C
Test standards	IEC 61643-11 / EN 61643-11

Type	Item No.	Pcs./Pkt.
SP-EE-FLT-T1-264/25-3+1-UT	1471822	1

# Surge protection

## Surge protection for the power supply

### Type 1+2 combined lightning current and surge arrester, 25 kA, Remote indication contact

High-performance, spark gap-based non-pluggable lightning current arrester / surge protective device for 3-phase power supply networks with separate N and PE (5-conductor system: L1, L2, L3, N, PE), for lightning protection levels I and II, with remote signaling.

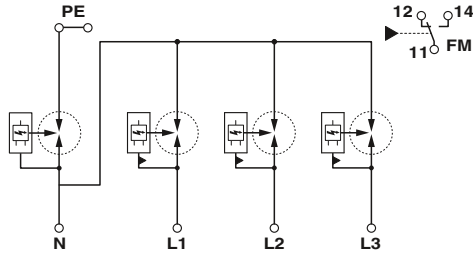

Technical data	
Nominal voltage $U_N$	240/415 V AC (TN-S) / 240/415 V AC (TT)
Mode of protection	L-N / L-PE / N-PE
Maximum continuous operating voltage $U_C$	264 V AC
Impulse discharge current $I_{imp}$ (10/350) $\mu$ s	25 kA / 25 kA / 100 kA
Nominal discharge current $I_n$ (8/20) $\mu$ s	25 kA / 25 kA / 100 kA
Max. discharge current $I_{max}$ (8/20) $\mu$ s	- / - / -
Protection level $U_p$	$\leq 1.5$ kV / $\leq 2.5$ kV / $\leq 1.5$ kV
Follow current interrupt rating $I_{fi}$	25 kA / - / 100 A
Short-circuit current rating $I_{SCCR}$	25 kA
Backup fuse	315 A (gG)
Remote indication contact	Changeover contact
Dimensions W/H/D	72 mm / 99.7 mm / 76.6 mm
IEC connection data Rigid/flexible/AWG	2.5 ... 35 mm <sup>2</sup> / 2.5 ... 25 mm <sup>2</sup> / 13 ... 2
Temperature range	-40 °C ... 85 °C
Test standards	IEC 61643-11 / EN 61643-11

Type	Item No.	Pcs./Pkt.
SP-EE-FLT-T1-264/25-3+1-UT-R	1471821	1

### Lightning/surge arrester type 1/2, TT, TN-S, 12.5 kA, 3L-N & N-PE, Remote indication contact

Universal varistor-based plug-in lightning/surge arrester for 3-phase power supply networks with separate N and PE (5-conductor system: L1, L2, L3, N, PE), for Lightning Protection Levels III and IV, with remote indication contact.

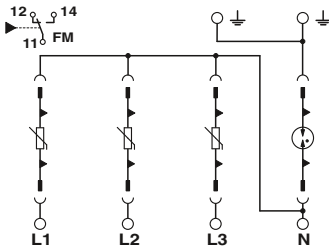

Technical data	
Nominal voltage $U_N$	240/415 V AC (TN-S) / 240/415 V AC (TT)
Mode of protection	L-N / L-PE / N-PE
Maximum continuous operating voltage $U_C$	335 V AC / 335 V AC / 264 V AC
Impulse discharge current $I_{imp}$ (10/350) $\mu$ s	12.5 kA / 12.5 kA / 50 kA
Nominal discharge current $I_n$ (8/20) $\mu$ s	12.5 kA / 12.5 kA / 50 kA
Max. discharge current $I_{max}$ (8/20) $\mu$ s	50 kA
Protection level $U_p$	$\leq 1.2$ kV / $\leq 2$ kV / $\leq 1.7$ kV
Follow current interrupt rating $I_{fi}$	- / - / 100 A
Short-circuit current rating $I_{SCCR}$	25 kA
Backup fuse	160 A (gG)
Remote indication contact	Changeover contact
Dimensions W/H/D	71.2 mm / 98.7 mm / 77.5 mm
IEC connection data Rigid/flexible/AWG	1.5 ... 35 mm <sup>2</sup> / 1.5 ... 25 mm <sup>2</sup> / 15 ... 2
Temperature range	-40 °C ... 80 °C
Test standards	IEC 61643-11 / EN 61643-11

Type	Item No.	Pcs./Pkt.
VAL-MS-EE-T1/T2-3+1-335-FM	2910550	1

#### Accessories

Replacement plug, L-N, 335 V AC  
Replacement plug, N-PE, 264 V AC

Type	Item No.	Pcs./Pkt.
VAL-MS-EE-T1/T2-335-P	2910556	10
F-MS-EE-T1/T2-50-P	2910557	10

### Lightning/surge arrester type 1/2, TT, TN-S, 12.5 kA, 3L-N & N-PE

Universal varistor-based plug-in lightning/surge arrester for 3-phase power supply networks with separate N and PE (5-conductor system: L1, L2, L3, N, PE), for Lightning Protection Levels III and IV.

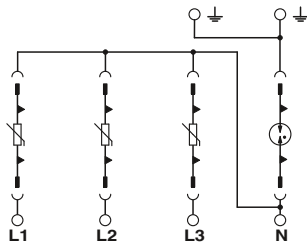

Technical data	
Nominal voltage $U_N$	240/415 V AC (TN-S) / 240/415 V AC (TT)
Mode of protection	L-N / L-PE / N-PE
Maximum continuous operating voltage $U_C$	335 V AC / 335 V AC / 264 V AC
Impulse discharge current $I_{imp}$ (10/350) $\mu$ s	12.5 kA / 12.5 kA / 50 kA
Nominal discharge current $I_n$ (8/20) $\mu$ s	12.5 kA / 12.5 kA / 50 kA
Max. discharge current $I_{max}$ (8/20) $\mu$ s	50 kA
Protection level $U_p$	$\leq 1.2$ kV / $\leq 2$ kV / $\leq 1.7$ kV
Follow current interrupt rating $I_{fi}$	- / - / 100 A
Short-circuit current rating $I_{SCCR}$	25 kA
Backup fuse	160 A (gG)
Dimensions W/H/D	71.2 mm / 89.8 mm / 77.5 mm
IEC connection data Rigid/flexible/AWG	1.5 ... 35 mm <sup>2</sup> / 1.5 ... 25 mm <sup>2</sup> / 15 ... 2
Temperature range	-40 °C ... 80 °C
Test standards	IEC 61643-11 / EN 61643-11

Type	Item No.	Pcs./Pkt.
VAL-MS-EE-T1/T2-3+1-335	2910551	1

#### Accessories

Replacement plug, L-N, 335 V AC  
Replacement plug, N-PE, 264 V AC

Type	Item No.	Pcs./Pkt.
VAL-MS-EE-T1/T2-335-P	2910556	10
F-MS-EE-T1/T2-50-P	2910557	10

### Lightning/surge arrester type 1/2, TN-C, 12.5 kA, 3L-PEN

Universal varistor-based plug-in lightning/surge arrester for 3-phase power supply networks with common N and PE (4-conductor system: L1, L2, L3, PEN).

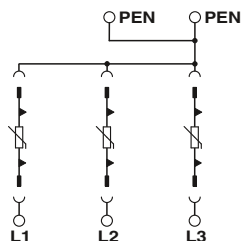

Technical data	
Nominal voltage $U_N$	240/415 V AC (TN-C)
Mode of protection	L-PEN
Maximum continuous operating voltage $U_C$	335 V AC
Impulse discharge current $I_{imp}$ (10/350) $\mu$ s	12.5 kA
Nominal discharge current $I_n$ (8/20) $\mu$ s	12.5 kA
Max. discharge current $I_{max}$ (8/20) $\mu$ s	50 kA
Protection level $U_p$	$\leq 1.2$ kV
Short-circuit current rating $I_{SCCR}$	25 kA
Backup fuse	160 A (gG)
Dimensions W/H/D	53.4 mm / 89.8 mm / 77.5 mm
IEC connection data Rigid/flexible/AWG	1.5 ... 35 mm <sup>2</sup> / 1.5 ... 25 mm <sup>2</sup> / 15 ... 2
Temperature range	-40 °C ... 80 °C
Test standards	IEC 61643-11 / EN 61643-11

	Type	Item No.	Pcs./Pkt.
	VAL-MS-EE-T1/T2-3+0-335	2910555	1

Accessories	Type	Item No.	Pcs./Pkt.
Replacement plug, L-N, 335 V AC	VAL-MS-EE-T1/T2-335-P	2910556	10

### Lightning/surge arrester type 1/2, TT, TN-S, 12.5 kA, 1L-N & N-PE, Remote indication contact

Universal varistor-based plug-in lightning/surge arrester for 1-phase power supply networks with separate N and PE (3-conductor system: L1, N, PE), with remote indication contact.

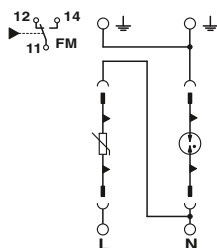

Technical data	
Nominal voltage $U_N$	240 V AC (TN-S) / 240 V AC (TT)
Mode of protection	L-N / L-PE / N-PE
Maximum continuous operating voltage $U_C$	335 V AC / 335 V AC / 264 V AC
Impulse discharge current $I_{imp}$ (10/350) $\mu$ s	12.5 kA / 12.5 kA / 50 kA
Nominal discharge current $I_n$ (8/20) $\mu$ s	12.5 kA / 12.5 kA / 50 kA
Max. discharge current $I_{max}$ (8/20) $\mu$ s	50 kA
Protection level $U_p$	$\leq 1.2$ kV / $\leq 2$ kV / $\leq 1.7$ kV
Follow current interrupt rating $I_{fi}$	- / - / 100 A
Short-circuit current rating $I_{SCCR}$	25 kA
Backup fuse	160 A (gG)
Remote indication contact	Changeover contact
Dimensions W/H/D	35.6 mm / 96.8 mm / 77.5 mm
IEC connection data Rigid/flexible/AWG	1.5 ... 35 mm <sup>2</sup> / 1.5 ... 25 mm <sup>2</sup> / 15 ... 2
Temperature range	-40 °C ... 80 °C
Test standards	IEC 61643-11 / EN 61643-11

	Type	Item No.	Pcs./Pkt.
	VAL-MS-EE-T1/T2-1+1-335-FM	2910552	1

Accessories	Type	Item No.	Pcs./Pkt.
Replacement plug, L-N, 335 V AC	VAL-MS-EE-T1/T2-335-P	2910556	10
Replacement plug, N-PE, 264 V AC	F-MS-EE-T1/T2-50-P	2910557	10

### Lightning/surge arrester type 1/2, TT, TN-S, 12.5 kA, 1L-N & N-PE

Universal varistor-based plug-in lightning/surge arrester for 1-phase power supply networks with separate N and PE (3-conductor system: L1, N, PE).

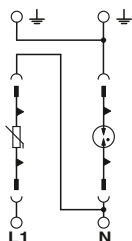

Technical data	
Nominal voltage $U_N$	240 V AC (TN-S) / 240 V AC (TT)
Mode of protection	L-N / L-PE / N-PE
Maximum continuous operating voltage $U_C$	335 V AC / 335 V AC / 264 V AC
Impulse discharge current $I_{imp}$ (10/350) $\mu$ s	12.5 kA / 12.5 kA / 50 kA
Nominal discharge current $I_n$ (8/20) $\mu$ s	12.5 kA / 12.5 kA / 50 kA
Max. discharge current $I_{max}$ (8/20) $\mu$ s	50 kA
Protection level $U_p$	$\leq 1.2$ kV / $\leq 2$ kV / $\leq 1.7$ kV
Follow current interrupt rating $I_{fi}$	- / - / 100 A
Short-circuit current rating $I_{SCCR}$	25 kA
Backup fuse	160 A (gG)
Dimensions W/H/D	35.6 mm / 89.8 mm / 77.5 mm
IEC connection data Rigid/flexible/AWG	1.5 ... 35 mm <sup>2</sup> / 1.5 ... 25 mm <sup>2</sup> / 15 ... 2
Temperature range	-40 °C ... 80 °C
Test standards	IEC 61643-11 / EN 61643-11

	Type	Item No.	Pcs./Pkt.
	VAL-MS-EE-T1/T2-1+1-335	2910553	1

Accessories	Type	Item No.	Pcs./Pkt.
Replacement plug, L-N, 335 V AC	VAL-MS-EE-T1/T2-335-P	2910556	10
Replacement plug, N-PE, 264 V AC	F-MS-EE-T1/T2-50-P	2910557	10

# Surge protection

## Surge protection for the power supply

### Type 2 surge arrester, TN-S, TT, 3L-N & N-PE, Remote indication contact

Surge arrester consisting of base element and protective connectors, for mounting on NS 35/7.5, execution: 230 V AC - IT system, 3 + 1 circuit.

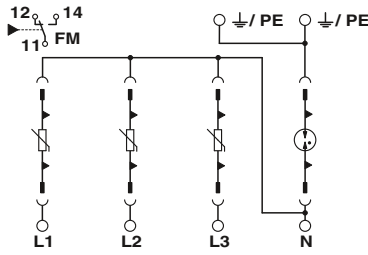

Technical data	
Nominal voltage $U_N$	240/415 V AC (TN-S) / 240/415 V AC (TT)
Mode of protection	L-N / L-PE / N-PE
Maximum continuous operating voltage $U_C$	385 V AC / 385 V AC / 260 V AC
Nominal discharge current $I_n$ (8/20) $\mu$ s	20 kA
Max. discharge current $I_{max}$ (8/20) $\mu$ s	40 kA
Protection level $U_p$	$\leq 1.8$ kV / $\leq 1.8$ kV / $\leq 1.5$ kV
Follow current interrupt rating $I_f$	- / - / 100 A
Short-circuit current rating $I_{SCCR}$	25 kA
Backup fuse	125 A (gG)
Remote indication contact	Changeover contact
Dimensions W/H/D	71 mm / 99 mm / 64.7 mm
IEC connection data Rigid/flexible/AWG	1.5 ... 35 mm <sup>2</sup> / 1.5 ... 25 mm <sup>2</sup> / 15 ... 2
Temperature range	-40 °C ... 80 °C
Test standards	IEC 61643-11 / EN 61643-11

Type	Item No.	Pcs./Pkt.
VAL-MS-EE-T2-3+1-385-FM	2910558	1

Accessories		Type	Item No.	Pcs./Pkt.
Replacement plug, L-N, 385 V AC	VAL-MS-EE-T2-385-P	2910569	10	
Replacement plug, N-PE, 260 V AC	F-MS-EE-T2-40-P	2910572	10	
Base element, Remote indication contact	VAL-MS-EE-T2-3+1-BE-FM	2910581	1	
Base element	VAL-MS-EE-T2-3+1-BE	2910582	1	

### Type 2 surge arrester, TN-S, TT, 3L-N & N-PE

Surge arrester consisting of base element and protective connectors, for mounting on NS 35/7.5, execution: 230 V AC - IT system, 3 + 1 circuit.

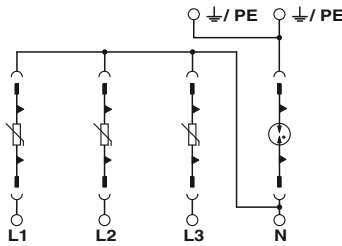

Technical data	
Nominal voltage $U_N$	240/415 V AC (TN-S) / 240/415 V AC (TT)
Mode of protection	L-N / L-PE / N-PE
Maximum continuous operating voltage $U_C$	385 V AC / 385 V AC / 260 V AC
Nominal discharge current $I_n$ (8/20) $\mu$ s	20 kA
Max. discharge current $I_{max}$ (8/20) $\mu$ s	40 kA
Protection level $U_p$	$\leq 1.8$ kV / $\leq 1.8$ kV / $\leq 1.5$ kV
Follow current interrupt rating $I_f$	- / - / 100 A
Short-circuit current rating $I_{SCCR}$	25 kA
Backup fuse	125 A (gG)
Dimensions W/H/D	71 mm / 90 mm / 64.7 mm
IEC connection data Rigid/flexible/AWG	1.5 ... 35 mm <sup>2</sup> / 1.5 ... 25 mm <sup>2</sup> / 15 ... 2
Temperature range	-40 °C ... 80 °C
Test standards	IEC 61643-11 / EN 61643-11

Type	Item No.	Pcs./Pkt.
VAL-MS-EE-T2-3+1-385	2910559	1

Accessories		Type	Item No.	Pcs./Pkt.
Replacement plug, L-N, 385 V AC	VAL-MS-EE-T2-385-P	2910569	10	
Replacement plug, N-PE, 260 V AC	F-MS-EE-T2-40-P	2910572	10	
Base element, Remote indication contact	VAL-MS-EE-T2-3+1-BE-FM	2910581	1	
Base element	VAL-MS-EE-T2-3+1-BE	2910582	1	

### Type 2 surge arrester, TN-S, TT, 3L-N & N-PE, Remote indication contact

Pluggable surge protective device, in accordance with Type 2/Class II, for 3-phase power supply networks with separate N and PE (5-conductor system: L1, L2, L3, N, PE), wired version, with remote indication contact.

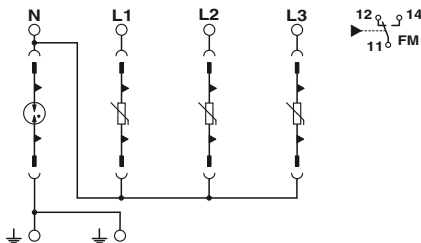

Technical data	
Nominal voltage $U_N$	240/415 V AC (TN-S) / 240/415 V AC (TT)
Mode of protection	L-N / L-PE / N-PE
Maximum continuous operating voltage $U_C$	385 V AC / 385 V AC / 260 V AC
Nominal discharge current $I_n$ (8/20) $\mu$ s	20 kA
Max. discharge current $I_{max}$ (8/20) $\mu$ s	40 kA
Protection level $U_p$	$\leq 2$ kV / $\leq 2.2$ kV / $\leq 1.5$ kV
Follow current interrupt rating $I_f$	- / - / 100 A
Short-circuit current rating $I_{SCCR}$	25 kA
Backup fuse	125 A (gG)
Remote indication contact	Changeover contact
Dimensions W/H/D	71 mm / 99 mm / 64.7 mm
IEC connection data Rigid/flexible/AWG	1.5 ... 35 mm <sup>2</sup> / 1.5 ... 25 mm <sup>2</sup> / 15 ... 2
Temperature range	-40 °C ... 80 °C
Test standards	IEC 61643-11 / EN 61643-11

Type	Item No.	Pcs./Pkt.
VAL-MS-EE-T2-3+1-385-UD-FM	2910560	1

Accessories		Type	Item No.	Pcs./Pkt.
Replacement plug, L-N, 385 V AC	VAL-MS-EE-T2-385-UD-P	1014954	10	
Replacement plug, N-PE, 260 V AC	F-MS-EE-T2-40-UD-P	1014952	10	
Base element, Remote indication contact	VAL-MS-EE-T2-3+1-BE-FM	2910581	1	
Base element	VAL-MS-EE-T2-3+1-BE	2910582	1	

### Type 2 surge arrester, TN, IT, 3L-PEN

Plug-in surge arrester, in accordance with Type 2/Class II, for 3-phase power supply networks with combined PE and N installed in one conductor (4-conductor system: L1, L2, L3, PEN).

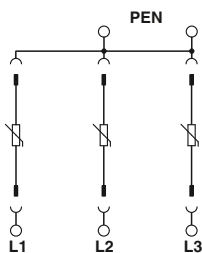

Technical data	
Nominal voltage $U_N$	240/415 V AC (TN) / 230 V AC (IT)
Mode of protection	L-N / L-PEN
Maximum continuous operating voltage $U_C$	385 V AC
Nominal discharge current $I_n$ (8/20) $\mu$ s	20 kA
Max. discharge current $I_{max}$ (8/20) $\mu$ s	40 kA
Protection level $U_p$	$\leq 1.8$ kV
Follow current interrupt rating $I_{fi}$	- / -
Short-circuit current rating $I_{SCCR}$	25 kA
Backup fuse	125 A (gG)
Dimensions W/H/D	53.4 mm / 90 mm / 64.7 mm
IEC connection data Rigid/flexible/AWG	1.5 ... 35 mm <sup>2</sup> / 1.5 ... 25 mm <sup>2</sup> / 15 ... 2
Temperature range	-40 °C ... 80 °C
Test standards	IEC 61643-11 / EN 61643-11

Type	Item No.	Pcs./Pkt.
VAL-MS-EE-T2-3+0-385	2910563	1

#### Accessories

Replacement plug, L-N, 385 V AC

Type	Item No.	Pcs./Pkt.
VAL-MS-EE-T2-385-P	2910569	10

### Type 2 surge arrester, Remote indication contact

Surge protection for low voltage systems



Technical data	
Nominal voltage $U_N$	240 V AC (L/N-PE)
Mode of protection	(L+) - PE / (L-) - PE
Maximum continuous operating voltage $U_C$	500 V DC ((DC+/DC-) - PE) / 500 V DC ((DC+/DC-) - PE)
Nominal discharge current $I_n$ (8/20) $\mu$ s	20 kA / 20 kA - / -
Max. discharge current $I_{max}$ (8/20) $\mu$ s	40 kA / 40 kA - / -
Protection level $U_p$	$\leq 1.8$ kV / $\leq 1.8$ kV - / -
Short-circuit current rating $I_{SCCR}$	25 kA
Remote indication contact	Changeover contact
Dimensions W/H/D	98.7 mm // 35.6 mm
IEC connection data Rigid/flexible/AWG	1.5 ... 35 mm <sup>2</sup> / 1.5 ... 25 mm <sup>2</sup> / 15 ... 2
Temperature range	-40 °C ... 80 °C
Test standards	IEC 61643-11 / IEC 61643-11

Type	Item No.	Pcs./Pkt.
VAL-MS-EE-T2-2+0-385-FM	1088258	1

#### Accessories

Replacement plug, L-N, 385 V AC

Type	Item No.	Pcs./Pkt.
VAL-MS-EE-T2-385-P	2910569	10

### Type 2 surge arrester, TN, IT, 2L-PEN

Plug-in surge arrester, in accordance with Type 2/Class II, for 2-phase power supply networks with combined PE and N installed in one conductor (3-conductor system: L1, L2, PEN).

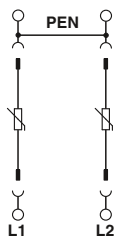

Technical data	
Nominal voltage $U_N$	240/415 V AC (TN) / 230 V AC (IT)
Mode of protection	L-N / L-PEN
Maximum continuous operating voltage $U_C$	385 V AC
Nominal discharge current $I_n$ (8/20) $\mu$ s	20 kA
Max. discharge current $I_{max}$ (8/20) $\mu$ s	40 kA
Protection level $U_p$	$\leq 1.8$ kV
Follow current interrupt rating $I_{fi}$	- / -
Short-circuit current rating $I_{SCCR}$	25 kA
Backup fuse	125 A (gG)
Dimensions W/H/D	35.6 mm / 90 mm / 64.7 mm
IEC connection data Rigid/flexible/AWG	1.5 ... 35 mm <sup>2</sup> / 1.5 ... 25 mm <sup>2</sup> / 15 ... 2
Temperature range	-40 °C ... 80 °C
Test standards	IEC 61643-11 / EN 61643-11

Type	Item No.	Pcs./Pkt.
VAL-MS-EE-T2-2+0-385	2910564	1

#### Accessories

Replacement plug, L-N, 385 V AC

Type	Item No.	Pcs./Pkt.
VAL-MS-EE-T2-385-P	2910569	10



# Surge protection

## Surge protection for the power supply

### Type 2 surge arrester, TN-S, TT, 1L-N & N-PE, Remote indication contact

Plug-in surge arrester, in accordance with Type 2/Class II, for 1-phase power supply networks with separate N and PE (3-conductor system: L1, N, PE), with remote indication contact.

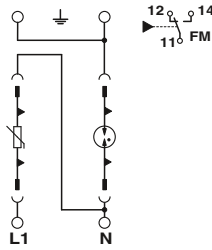

Technical data	
Nominal voltage $U_N$	240/415 V AC (TN-S) / 240/415 V AC (TT)
Mode of protection	L-N / L-PE / N-PE
Maximum continuous operating voltage $U_C$	385 V AC / 385 V AC / 260 V AC
Nominal discharge current $I_n$ (8/20) $\mu$ s	20 kA
Max. discharge current $I_{max}$ (8/20) $\mu$ s	40 kA
Protection level $U_p$	$\leq 1.8$ kV / $\leq 1.8$ kV / $\leq 1.5$ kV
Follow current interrupt rating $I_{fi}$	- / - / 100 A
Short-circuit current rating $I_{SCCR}$	25 kA
Backup fuse	125 A AC (gG)
Remote indication contact	Changeover contact
Dimensions W/H/D	35.6 mm / 97 mm / 65.5 mm
IEC connection data Rigid/flexible/AWG	1.5 ... 35 mm <sup>2</sup> / 1.5 ... 25 mm <sup>2</sup> / 15 ... 2
Temperature range	-40 °C ... 80 °C
Test standards	IEC 61643-11 / EN 61643-11

Type	Item No.	Pcs./Pkt.
VAL-MS-EE-T2-1+1-385-FM	2910561	1

Accessories		Type	Item No.	Pcs./Pkt.
Replacement plug, L-N, 385 V AC		VAL-MS-EE-T2-385-P	2910569	10
Replacement plug, N-PE, 260 V AC		F-MS-EE-T2-40-P	2910572	10

### Type 2 surge arrester, TN-S, TT, 1L-N & N-PE

Plug-in surge arrester, in accordance with Type 2/Class II, for 1-phase power supply networks with separate N and PE (3-conductor system: L1, N, PE).

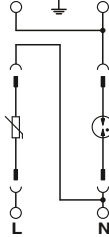

Technical data	
Nominal voltage $U_N$	240/415 V AC (TN-S) / 240/415 V AC (TT)
Mode of protection	L-N / L-PE / N-PE
Maximum continuous operating voltage $U_C$	385 V AC / - / 260 V AC
Nominal discharge current $I_n$ (8/20) $\mu$ s	20 kA
Max. discharge current $I_{max}$ (8/20) $\mu$ s	40 kA
Protection level $U_p$	$\leq 1.8$ kV / $\leq 1.8$ kV / $\leq 1.5$ kV
Follow current interrupt rating $I_{fi}$	- / - / 100 A
Short-circuit current rating $I_{SCCR}$	25 kA
Backup fuse	125 A (gG)
Dimensions W/H/D	35.6 mm / 90 mm / 64.7 mm
IEC connection data Rigid/flexible/AWG	1.5 ... 35 mm <sup>2</sup> / 1.5 ... 25 mm <sup>2</sup> / 15 ... 2
Temperature range	-40 °C ... 80 °C
Test standards	IEC 61643-11 / EN 61643-11

Type	Item No.	Pcs./Pkt.
VAL-MS-EE-T2-1+1-385	2910562	1

Accessories		Type	Item No.	Pcs./Pkt.
Replacement plug, L-N, 385 V AC		VAL-MS-EE-T2-385-P	2910569	10
Replacement plug, N-PE, 260 V AC		F-MS-EE-T2-40-P	2910572	10

### Type 2 surge arrester, Remote indication contact

Surge arrester consisting of base element with remote indicator contact and protective connector with high-capacity varistor, for mounting on NS 35/7.5, 1-channel

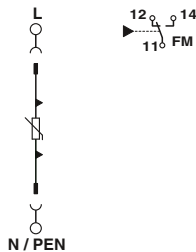

Technical data	
Nominal voltage $U_N$	240/415 V AC (TN) / 230 V AC (IT)
Mode of protection	L-N / L-PEN
Maximum continuous operating voltage $U_C$	385 V AC
Nominal discharge current $I_n$ (8/20) $\mu$ s	20 kA -
Max. discharge current $I_{max}$ (8/20) $\mu$ s	40 kA / -
Protection level $U_p$	$\leq 1.8$ kV
Follow current interrupt rating $I_{fi}$	- / -
Short-circuit current rating $I_{SCCR}$	25 kA
Backup fuse	125 A AC (gG)
Remote indication contact	Changeover contact
Dimensions W/H/D	17.8 mm / 99 mm / 65.5 mm
IEC connection data Rigid/flexible/AWG	1.5 ... 35 mm <sup>2</sup> / 1.5 ... 25 mm <sup>2</sup> / 15 ... 2
Temperature range	-40 °C ... 80 °C
Test standards	IEC 61643-11 / EN 61643-11

Type	Item No.	Pcs./Pkt.
VAL-MS-EE-T2-1+0-385-FM	1185335	1

Accessories		Type	Item No.	Pcs./Pkt.
Replacement plug, L-N, 385 V AC		VAL-MS-EE-T2-385-P	2910569	10



### Type 2 surge arrester, TN, IT, 1L-PEN

Plug-in surge arrester, in accordance with Type 2/Class II, for 1-phase power supply networks with combined PE and N installed in one conductor (3-conductor system: L1, PEN)

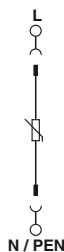

Technical data	
Nominal voltage $U_N$	240/415 V AC (TN) / 230 V AC (IT)
Mode of protection	L-N / L-PEN
Maximum continuous operating voltage $U_C$	385 V AC
Nominal discharge current $I_n$ (8/20) $\mu$ s	20 kA
Max. discharge current $I_{max}$ (8/20) $\mu$ s	40 kA
Protection level $U_p$	$\leq 1.8$ kV
Follow current interrupt rating $I_{fi}$	- / -
Short-circuit current rating $I_{SCCR}$	25 kA
Backup fuse	125 A AC (gG)
Dimensions W/H/D	35.6 mm / 90 mm / 64.7 mm
IEC connection data Rigid/flexible/AWG	1.5 ... 35 mm <sup>2</sup> / 1.5 ... 25 mm <sup>2</sup> / 15 ... 2
Temperature range	-40 °C ... 80 °C
Test standards	IEC 61643-11 / EN 61643-11

Type	Item No.	Pcs./Pkt.
VAL-MS-EE-T2-1+0-385	2910565	1

#### Accessories

Replacement plug, L-N, 385 V AC

Base element

Base element, Remote indication contact

Type	Item No.	Pcs./Pkt.
VAL-MS-EE-T2-385-P	2910569	10
VAL-MS-EE-T2-BE	2910584	10
VAL-MS-EE-T2-BE-FM	2910573	10

### Type 2 surge arrester, TN, DC, 1L-PEN, Remote indication contact

Plug-in surge arrester, in accordance with Type 2/Class II, for 1-phase power supply networks with combined PE and N installed in one conductor (3-conductor system: L1, PEN), with remote indication contact.

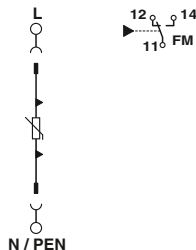

Technical data	
Nominal voltage $U_N$	60 V AC (TN)
Mode of protection	L-PEN
Maximum continuous operating voltage $U_C$	75 V AC / 100 V DC
Nominal discharge current $I_n$ (8/20) $\mu$ s	15 kA
Max. discharge current $I_{max}$ (8/20) $\mu$ s	40 kA
Protection level $U_p$	$\leq 0.55$ kV
Short-circuit current rating $I_{SCCR}$	25 kA
Backup fuse	125 A AC (gG)
Remote indication contact	Changeover contact
Dimensions W/H/D	17.6 mm / 97 mm / 65.5 mm
IEC connection data Rigid/flexible/AWG	1.5 ... 35 mm <sup>2</sup> / 1.5 ... 25 mm <sup>2</sup> / 15 ... 2
Temperature range	-40 °C ... 80 °C
Test standards	IEC 61643-11 / EN 61643-11

Type	Item No.	Pcs./Pkt.
VAL-MS-EE-T2-1+0-75-FM	2910566	1

#### Accessories

Replacement plug, L-PEN, 75 V AC

Base element

Base element, Remote indication contact

Type	Item No.	Pcs./Pkt.
VAL-MS-EE-T2-75-P	2910571	10
VAL-MS-EE-T2-BE	2910584	10
VAL-MS-EE-T2-BE-FM	2910573	10

### Type 2 surge arrester, TN, DC, 1L-PEN

Plug-in surge arrester, in accordance with Type 2/Class II, for 1-phase power supply networks with combined PE and N installed in one conductor (3-conductor system: L1, PEN)

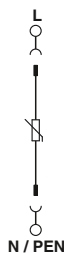

Technical data	
Nominal voltage $U_N$	60 V AC (TN)
Mode of protection	L-PEN
Maximum continuous operating voltage $U_C$	75 V AC / 100 V DC
Nominal discharge current $I_n$ (8/20) $\mu$ s	15 kA
Max. discharge current $I_{max}$ (8/20) $\mu$ s	40 kA
Protection level $U_p$	$\leq 0.55$ kV
Short-circuit current rating $I_{SCCR}$	25 kA
Backup fuse	125 A AC (gG)
Dimensions W/H/D	17.6 mm / 90 mm / 64.7 mm
IEC connection data Rigid/flexible/AWG	1.5 ... 35 mm <sup>2</sup> / 1.5 ... 25 mm <sup>2</sup> / 15 ... 2
Temperature range	-40 °C ... 80 °C
Test standards	IEC 61643-11 / EN 61643-11

Type	Item No.	Pcs./Pkt.
VAL-MS-EE-T2-1+0-75	2910568	1

#### Accessories

Replacement plug, L-PEN, 75 V AC

Base element

Base element, Remote indication contact

Type	Item No.	Pcs./Pkt.
VAL-MS-EE-T2-75-P	2910571	10
VAL-MS-EE-T2-BE	2910584	10
VAL-MS-EE-T2-BE-FM	2910573	10

# Surge protection

## Surge protection for the power supply

### Type 2 surge arrester, TN-S, TT, 3L-N & N-PE, Remote indication contact

Surge protective device combination, 4-channel, for installation on NS 35/7,5, with remote indication contact (FM) as changeover contact, voltage 230 V AC

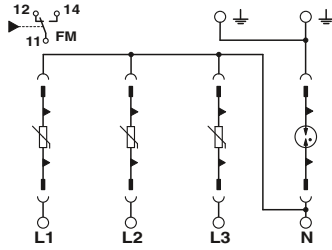

Technical data	
Nominal voltage $U_N$	240/415 V AC (TN-S) / 240/415 V AC (TT)
Mode of protection	L-N / L-PE / N-PE
Maximum continuous operating voltage $U_C$	335 V AC / 335 V AC / 260 V AC
Nominal discharge current $I_n$ (8/20) $\mu$ s	20 kA
Max. discharge current $I_{max}$ (8/20) $\mu$ s	40 kA
Protection level $U_p$	$\leq 1.6$ kV / $\leq 1.9$ kV / $\leq 1.5$ kV
Follow current interrupt rating $I_f$	- / - / 100 A
Short-circuit current rating $I_{SCCR}$	25 kA
Backup fuse	125 A (gG)
Remote indication contact	Changeover contact
Dimensions W/H/D	71 mm / 99 mm / 64.7 mm
IEC connection data Rigid/flexible/AWG	1.5 ... 35 mm <sup>2</sup> / 1.5 ... 25 mm <sup>2</sup> / 15 ... 2
Temperature range	-40 °C ... 80 °C
Test standards	IEC 61643-11 / EN 61643-11

Type	Item No.	Pcs./Pkt.
VAL-MS-EE-T2-3+1-320-FM	2910574	1

Accessories		Type	Item No.	Pcs./Pkt.
Type 2 surge protection device, TN, TT	F-MS-EE-T2-40	2910578	1	
Replacement plug, L-PEN, 335 V AC	VAL-MS-EE-T2-320-P	2910579	10	
Base element, Remote indication contact	VAL-MS-EE-T2-3+1-BE-FM	2910581	1	
Base element	VAL-MS-EE-T2-3+1-BE	2910582	1	

### Type 2 surge arrester, TN-S, TT, 3L-N & N-PE

Surge protective device, 4-channel (in 3+1 circuit), for installation on NS 35/7,5 voltage: 230 V AC

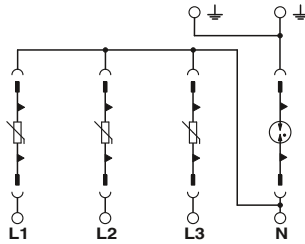

Technical data	
Nominal voltage $U_N$	240/415 V AC (TN-S) / 240/415 V AC (TT)
Mode of protection	L-N / L-PE / N-PE
Maximum continuous operating voltage $U_C$	335 V AC / 335 V AC / 260 V AC
Nominal discharge current $I_n$ (8/20) $\mu$ s	20 kA
Max. discharge current $I_{max}$ (8/20) $\mu$ s	40 kA
Protection level $U_p$	$\leq 1.6$ kV / $\leq 1.9$ kV / $\leq 1.5$ kV
Follow current interrupt rating $I_f$	- / - / 100 A
Short-circuit current rating $I_{SCCR}$	25 kA
Backup fuse	125 A (gG)
Dimensions W/H/D	71 mm / 90 mm / 64.7 mm
IEC connection data Rigid/flexible/AWG	1.5 ... 35 mm <sup>2</sup> / 1.5 ... 25 mm <sup>2</sup> / 15 ... 2
Temperature range	-40 °C ... 80 °C
Test standards	IEC 61643-11 / EN 61643-11

Type	Item No.	Pcs./Pkt.
VAL-MS-EE-T2-3+1-320	2910575	1

Accessories		Type	Item No.	Pcs./Pkt.
Type 2 surge protection device, TN, TT	F-MS-EE-T2-40	2910578	1	
Replacement plug, L-PEN, 335 V AC	VAL-MS-EE-T2-320-P	2910579	10	
Base element, Remote indication contact	VAL-MS-EE-T2-3+1-BE-FM	2910581	1	
Base element	VAL-MS-EE-T2-3+1-BE	2910582	1	

### Type 2 surge arrester, TN-S, TT, 1L-N & N-PE, Remote indication contact

Plug-in surge arrester, in accordance with Type 2/Class II, for 1-phase power supply networks with separate N and PE (3-conductor system: L1, N, PE), with remote indication contact.

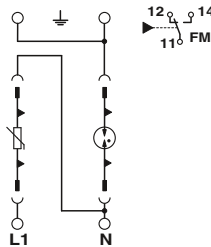

Technical data	
Nominal voltage $U_N$	240/415 V AC (TN-S) / 240/415 V AC (TT)
Mode of protection	L-N / L-PE / N-PE
Maximum continuous operating voltage $U_C$	335 V AC / 335 V AC / 260 V AC
Nominal discharge current $I_n$ (8/20) $\mu$ s	20 kA
Max. discharge current $I_{max}$ (8/20) $\mu$ s	40 kA
Protection level $U_p$	$\leq 1.5$ kV / $\leq 1.9$ kV / $\leq 1.5$ kV
Follow current interrupt rating $I_f$	- / - / 100 A
Short-circuit current rating $I_{SCCR}$	25 kA
Backup fuse	125 A AC (gG)
Remote indication contact	Changeover contact
Dimensions W/H/D	35.6 mm / 99 mm / 65.5 mm
IEC connection data Rigid/flexible/AWG	1.5 ... 35 mm <sup>2</sup> / 1.5 ... 25 mm <sup>2</sup> / 15 ... 2
Temperature range	-40 °C ... 80 °C
Test standards	IEC 61643-11 / EN 61643-11

Type	Item No.	Pcs./Pkt.
VAL-MS-EE-T2-1+1-320-FM	1185339	1

Accessories		Type	Item No.	Pcs./Pkt.
Type 2 surge protection device, TN, TT	F-MS-EE-T2-40	2910578	1	
Replacement plug, L-PEN, 335 V AC	VAL-MS-EE-T2-320-P	2910579	10	
Base element, Remote indication contact	VAL-MS-EE-T2-3+1-BE-FM	2910581	1	
Base element	VAL-MS-EE-T2-3+1-BE	2910582	1	

### Type 2 surge arrester, TN-S, TT, 1L-N & N-PE, Remote indication contact

Plug-in surge arrester, in accordance with Type 2/Class II, for 1-phase power supply networks with separate N and PE (3-conductor system: L, N, PE).

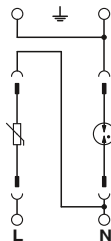

Technical data	
Nominal voltage $U_N$	240/415 V AC (TN-S) / 240/415 V AC (TT)
Mode of protection	L-N / L-PE / N-PE
Maximum continuous operating voltage $U_C$	335 V AC / 335 V AC / 260 V AC
Nominal discharge current $I_n$ (8/20) $\mu$ s	20 kA
Max. discharge current $I_{max}$ (8/20) $\mu$ s	40 kA
Protection level $U_p$	$\leq 1.5$ kV / $\leq 1.9$ kV / $\leq 1.5$ kV
Follow current interrupt rating $I_f$	- / - / 100 A
Short-circuit current rating $I_{SCCR}$	25 kA
Backup fuse	125 A (gG)
Remote indication contact	Changeover contact
Dimensions W/H/D	35.6 mm / 90 mm / 65.5 mm
IEC connection data Rigid/flexible/AWG	1.5 ... 35 mm <sup>2</sup> / 1.5 ... 25 mm <sup>2</sup> / 15 ... 2
Temperature range	-40 °C ... 80 °C
Test standards	IEC 61643-11 / EN 61643-11

Type	Item No.	Pcs./Pkt.
VAL-MS-EE-T2-1+1-320	1185337	1

#### Accessories

Accessories	Type	Item No.	Pcs./Pkt.
Type 2 surge protection device, TN, TT	F-MS-EE-T2-40	2910578	1
Replacement plug, L-PEN, 335 V AC	VAL-MS-EE-T2-320-P	2910579	10
Base element, Remote indication contact	VAL-MS-EE-T2-3+1-BE-FM	2910581	1
Base element	VAL-MS-EE-T2-3+1-BE	2910582	1

### Type 2 surge arrester, TN, TT, 1L-PEN, Remote indication contact

Surge arrester consisting of base element with remote indicator contact and protective connector with high-capacity varistor, for mounting on NS 35/7.5, 1-channel

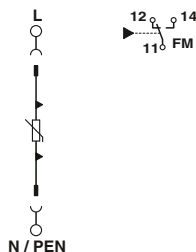

Technical data	
Nominal voltage $U_N$	240/415 V AC (TN) / 240/415 V AC (TT)
Mode of protection	L-PEN
Maximum continuous operating voltage $U_C$	335 V AC
Nominal discharge current $I_n$ (8/20) $\mu$ s	20 kA
Max. discharge current $I_{max}$ (8/20) $\mu$ s	40 kA
Protection level $U_p$	$\leq 1.5$ kV
Short-circuit current rating $I_{SCCR}$	25 kA
Backup fuse	125 A (gG)
Remote indication contact	Changeover contact
Dimensions W/H/D	17.6 mm / 97 mm / 65.5 mm
IEC connection data Rigid/flexible/AWG	1.5 ... 35 mm <sup>2</sup> / 1.5 ... 25 mm <sup>2</sup> / 15 ... 2
Temperature range	-40 °C ... 80 °C
Test standards	IEC 61643-11 / EN 61643-11

Type	Item No.	Pcs./Pkt.
VAL-MS-EE-T2-1+0-320-FM	2910576	1

#### Accessories

Accessories	Type	Item No.	Pcs./Pkt.
Type 2 surge protection device, TN, TT	F-MS-EE-T2-40	2910578	1
Replacement plug, L-PEN, 335 V AC	VAL-MS-EE-T2-320-P	2910579	10
Base element	VAL-MS-EE-T2-BE	2910584	10

### Type 2 surge arrester, TN, TT, 1L-PEN

Surge arresters consisting of base element and protective connector with high-capacity varistor, for mounting on NS 35/7.5, 1-channel

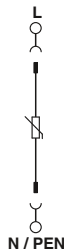

Technical data	
Nominal voltage $U_N$	240/415 V AC (TN) / 240/415 V AC (TT)
Mode of protection	L-PEN
Maximum continuous operating voltage $U_C$	335 V AC
Nominal discharge current $I_n$ (8/20) $\mu$ s	20 kA
Max. discharge current $I_{max}$ (8/20) $\mu$ s	40 kA
Protection level $U_p$	$\leq 1.5$ kV
Short-circuit current rating $I_{SCCR}$	25 kA
Backup fuse	125 A (gG)
Dimensions W/H/D	17.6 mm / 90 mm / 64.7 mm
IEC connection data Rigid/flexible/AWG	1.5 ... 35 mm <sup>2</sup> / 1.5 ... 25 mm <sup>2</sup> / 15 ... 2
Temperature range	-40 °C ... 80 °C
Test standards	IEC 61643-11 / EN 61643-11

Type	Item No.	Pcs./Pkt.
VAL-MS-EE-T2-1+0-320	2910577	1

#### Accessories

Accessories	Type	Item No.	Pcs./Pkt.
Type 2 surge protection device, TN, TT	F-MS-EE-T2-40	2910578	1
Replacement plug, L-PEN, 335 V AC	VAL-MS-EE-T2-320-P	2910579	10
Base element	VAL-MS-EE-T2-BE	2910584	10

# Surge protection

## Surge protection for the power supply

### Type 3 surge protection device, 24 V, Remote indication contact

Type 3 surge protection, consisting of protective plug and base element with screw connection, with integrated status indicator and remote signaling for single-phase power supply networks. Nominal voltage: 24 V AC/DC

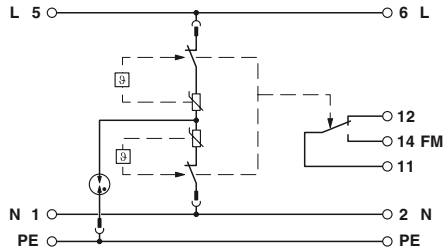

Technical data	
IEC test classification	III, T3
Nominal voltage $U_N$	24 V AC
Mode of protection	L-N / L-PE / N-PE
Maximum continuous operating voltage $U_C$	34 V AC
Nominal load current $I_L$	16 A (at 63 °C)
Nominal discharge current $I_n$ (8/20) $\mu$ s	1 kA
Combined surge $U_{OC}$	2 kV
Protection level $U_p$	$\leq 0.2$ kV / $\leq 0.6$ kV
Short-circuit current rating $I_{SCCR}$	6 kA AC
Backup fuse	16 A (gG / B / C)
Dimensions W/H/D	17.7 mm / 93.4 mm / 71.3 mm
IEC connection data Rigid/flexible/AWG	0.2...4 mm <sup>2</sup> / / 0.2...2.5 mm <sup>2</sup> / 24 ... 12
Temperature range	-40 °C ... 80 °C
Test standards	IEC 61643-11 / EN 61643-11
Remote indication contact	Changeover contact

	Type	Item No.	Pcs./Pkt.
	PLT-EE-T3-24DC-R	1249054	5
<b>Accessories</b>			
Replacement plug	PLT-EE-T3-24DC-P	1249053	10
Base element	PLT-EE-T3-BE-R	1249061	10

### Type 3 surge protection device, 60 V, Remote indication contact

Type 3 surge protection, consisting of protective plug and base element with screw connection, with integrated status indicator and remote signaling for single-phase power supply networks. Nominal voltage: 60 V AC

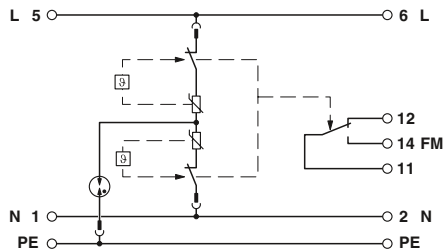

Technical data	
IEC test classification	III, T3
Nominal voltage $U_N$	60 V AC
Mode of protection	L-N / L-PE / N-PE
Maximum continuous operating voltage $U_C$	80 V AC
Nominal load current $I_L$	16 A (at 63 °C)
Nominal discharge current $I_n$ (8/20) $\mu$ s	2 kA
Combined surge $U_{OC}$	4 kV
Protection level $U_p$	$\leq 0.48$ kV / $\leq 0.8$ kV
Short-circuit current rating $I_{SCCR}$	6 kA AC
Backup fuse	16 A (gG / B / C)
Dimensions W/H/D	17.7 mm / 93.4 mm / 71.3 mm
IEC connection data Rigid/flexible/AWG	0.2...4 mm <sup>2</sup> / / 0.2...2.5 mm <sup>2</sup> / 24 ... 12
Temperature range	-40 °C ... 80 °C
Test standards	IEC 61643-11 / EN 61643-11
Remote indication contact	Changeover contact

	Type	Item No.	Pcs./Pkt.
	PLT-EE-T3-60AC-R	1249056	5
<b>Accessories</b>			
Replacement plug	PLT-EE-T3-60AC-P	1249055	10
Base element	PLT-EE-T3-BE-R	1249061	10

### Type 3 surge protection device, 120 V, Remote indication contact

Type 3 surge protection, consisting of protective plug and base element with screw connection, with integrated status indicator and remote signaling for single-phase power supply networks. Nominal voltage: 120 V AC

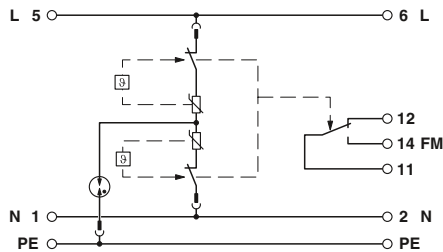

Technical data	
IEC test classification	III, T3
Nominal voltage $U_N$	120 V AC
Mode of protection	L-N / L-PE / N-PE
Maximum continuous operating voltage $U_C$	150 V AC
Nominal load current $I_L$	16 A (at 63 °C)
Nominal discharge current $I_n$ (8/20) $\mu$ s	3 kA
Combined surge $U_{OC}$	6 kV
Protection level $U_p$	$\leq 0.75$ kV (at $U_{OC}$ ) / $\leq 0.85$ kV
Short-circuit current rating $I_{SCCR}$	6 kA AC
Backup fuse	16 A (gG / B / C)
Dimensions W/H/D	17.7 mm / 93.4 mm / 71.3 mm
IEC connection data Rigid/flexible/AWG	0.2...4 mm <sup>2</sup> / / 0.2...2.5 mm <sup>2</sup> / 24 ... 12
Temperature range	-40 °C ... 80 °C
Test standards	IEC 61643-11 / EN 61643-11
Remote indication contact	Changeover contact

	Type	Item No.	Pcs./Pkt.
	PLT-EE-T3-120AC-R	1249058	5
<b>Accessories</b>			
Replacement plug	PLT-EE-T3-120AC-P	1249057	10
Base element	PLT-EE-T3-BE-R	1249061	10

### Type 3 surge protection device, 240 V, Remote indication contact

Type 3 surge protection, consisting of protective plug and base element with screw connection, with integrated status indicator and remote signaling for single-phase power supply networks. Nominal voltage: 230 V AC

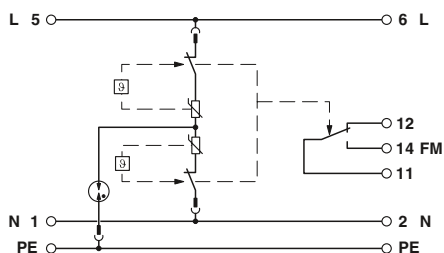

Technical data	
IEC test classification	III, T3
Nominal voltage $U_N$	240 V AC
Mode of protection	L-N / L-PE / N-PE
Maximum continuous operating voltage $U_C$	264 V AC
Nominal load current $I_L$	16 A (at 63 °C)
Nominal discharge current $I_n$ (8/20) $\mu$ s	3 kA
Combined surge $U_{OC}$	6 kV
Protection level $U_p$	$\leq 1.25$ kV (at $U_{OC}$ ) / $\leq 1.4$ kV
Short-circuit current rating $I_{SCCR}$	6 kA AC
Backup fuse	16 A (gG / B / C)
Dimensions W/H/D	17.7 mm / 93.4 mm / 71.3 mm
IEC connection data Rigid/flexible/AWG	0.2...4 mm <sup>2</sup> / 0.2...2.5 mm <sup>2</sup> / 24 ... 12
Temperature range	-40 °C ... 80 °C
Test standards	IEC 61643-11 / EN 61643-11
Remote indication contact	Changeover contact

	Type	Item No.	Pcs./Pkt.
	PLT-EE-T3-230AC-R	1249060	5
<b>Accessories</b>			
Replacement plug	PLT-EE-T3-230AC-P	1249059	10
Base element	PLT-EE-T3-BE-R	1249061	10

### Surge protection device, Fine/coarse protection decoupled, 2-conductor technology, LON bus

Surge protection for a 2-wire floating signal circuit, e.g., 0(4) ... 20 mA current loop, HART-compatible.

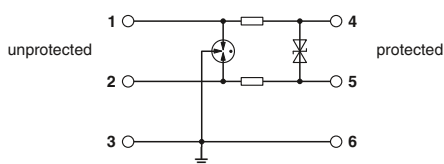

Technical data	
IEC test classification/EN type	C1 / C2 / C3 / D1
Connection method	Screw connection
Connection cross section	0.2 mm <sup>2</sup> ...4 mm <sup>2</sup> / 24...12 AWG
Nominal voltage $U_N$	24 V DC
Direction of action	Line-Line & Line-Signal Ground/Shield & optional Signal Ground/Shield-Earth Ground
Maximum continuous operating voltage $U_C$	30 V DC / 21 V AC
Rated current	500 mA (40 °C)
Nominal discharge current $I_n$ (8/20) $\mu$ s (Core-Core)	5 kA
Nominal discharge current $I_n$ (8/20) $\mu$ s (Core-Earth)	5 kA
Total discharge current $I_{total}$ (8/20) $\mu$ s	10 kA
Voltage protection level $U_p$ (core-core)	$\leq 55$ V (C1 - 1 kV / 500 A)
Voltage protection level $U_p$ (core-ground)	$\leq 750$ V (C1 - 1 kV / 500 A)
Cut-off frequency $f_g$ (3 dB) in a 150 $\Omega$ system (symmetrical)	typ. 940 kHz

	Type	Item No.	Pcs./Pkt.
	SP-EE-TT-6-1X2-24DC-UT	1445846	1

### Surge protection device, Fine/coarse protection decoupled

Surge protection for two signal wires with common reference potential, e.g., Digital IN/OUT.

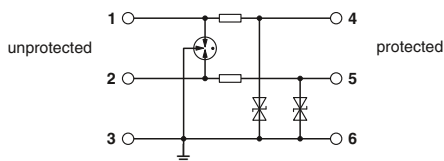

Technical data	
IEC test classification/EN type	C1 / C2 / C3 / D1
Connection method	Screw connection
Connection cross section	0.2 mm <sup>2</sup> ...4 mm <sup>2</sup> / 24...12 AWG
Nominal voltage $U_N$	24 V DC
Direction of action	Line-Line & Line-Signal Ground/Shield & optional Signal Ground/Shield-Earth Ground
Maximum continuous operating voltage $U_C$	30 V DC / 21 V AC
Rated current	500 mA (40 °C)
Nominal discharge current $I_n$ (8/20) $\mu$ s (Core-Earth)	5 kA
Total discharge current $I_{total}$ (8/20) $\mu$ s	10 kA
Voltage protection level $U_p$ (core-ground)	$\leq 140$ V (C1 - 1 kV / 500 A)

	Type	Item No.	Pcs./Pkt.
	SP-EE-TT-6-2X1-24DC-UT	1445833	1

# Surge protection

## Surge protection for the power supply

### Surge protection device, Fine/coarse protection

Surge protection for resistance-dependent measuring signals.

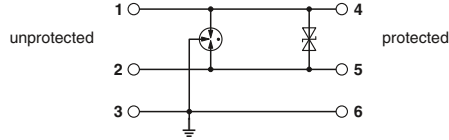

Technical data	
IEC test classification/EN type	C1 / C2 / C3 / D1
Connection method	Screw connection
Connection cross section	0.2 mm <sup>2</sup> ...4 mm <sup>2</sup> / 24...12 AWG
Nominal voltage U <sub>N</sub>	24 V DC
Direction of action	Line-Line & Line-Signal Ground/Shield & optional Signal Ground/Shield-Earth Ground
Maximum continuous operating voltage U <sub>C</sub>	30 V DC / 21 V AC
Rated current	350 mA (80 °C)
Nominal discharge current I <sub>n</sub> (8/20) μs (Core-Core)	0.5 kA
Nominal discharge current I <sub>n</sub> (8/20) μs (Core-Earth)	5 kA
Total discharge current I <sub>total</sub> (8/20) μs	10 kA
Voltage protection level U <sub>p</sub> (core-core)	≤ 60 V (C1 - 1 kV / 500 A)
Voltage protection level U <sub>p</sub> (core-ground)	≤ 650 V (C1 - 1 kV / 500 A)
Cut-off frequency fg (3 dB) in a 150 Ω system (symmetrical)	typ. 965 kHz

Type	Item No.	Pcs./Pkt.
SP-EE-TT-6-2-24DC-UT	1446156	1

### Surge protection device, Fine/coarse protection decoupled, RS-485

Surge protection for three signal wires with common reference potential. For HF applications and telecommunications interfaces without supply voltage (up to 90 Mbps).

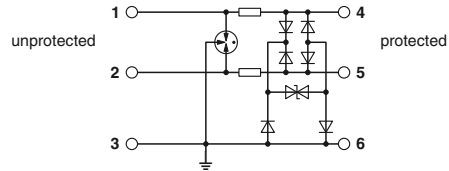

Technical data	
IEC test classification/EN type	C1 / C2 / C3 / D1
Nominal voltage U <sub>N</sub>	12 V DC
Maximum continuous operating voltage U <sub>C</sub>	15 V DC/10 V AC
Rated current	500 mA (40 °C)
Nominal discharge current I <sub>n</sub> (8/20) μs (Core-Core)	5 kA
Nominal discharge current I <sub>n</sub> (8/20) μs (Core-Earth)	5 kA
Total discharge current I <sub>total</sub> (8/20) μs	10 kA
Voltage protection level U <sub>p</sub> (core-core)	≤ 45 V (C1 - 1 kV / 500 A)
Voltage protection level U <sub>p</sub> (core-ground)	≤ 50 V (C1 - 1 kV / 500 A)
Cut-off frequency fg (3 dB) in a 150 Ω system (symmetrical)	typ. 60 MHz
Connection method	Screw connection
Connection cross section	0.2 mm <sup>2</sup> ...4 mm <sup>2</sup> //24...12 AWG

Type	Item No.	Pcs./Pkt.
SP-EE-TT-6-3-HF-12DC-UT	1446151	1





# Power supplies



## Power supplies

Phoenix Contact offers a broad portfolio of power supplies for various applications.

With a wide range of performance classes and functions to choose from, you will find the ideal industrial solution, e.g., for machine building, the semiconductor industry, or control cabinet building.

## Product range overview

1-phase power supplies	<b>58</b>
3-phase power supplies	<b>60</b>

**Reliable supply**



The power supplies in the ESSENTIAL edition family are the ideal choice for supplying your system reliably using basic functions. They meet essential industry standards and also offer additional features at an attractive price. These include an international approval package, wide temperature range, and flexible wide range input. ESSENTIAL edition is therefore ideally suited for worldwide use.



**Vibration and shock resistance**

The robust design of the mechanical and electrical components tolerates sustained vibrations of up to 2.3g in resonance and shocks of up to 15g for 15 ms.



**Self-protecting**

Various protective mechanisms ensure comprehensive device protection at all times. Internal protective circuits take effect in the event of an overvoltage, overcurrent, or excessively high temperature. The device protects itself from any harm.

**Your advantages:**

- ✓ Worldwide application, thanks to the wide range input and international approval package
- ✓ Immunity to voltage dips at the output with the SEMI-F47 standard
- ✓ Greater availability, thanks to fan-free convection cooling



### For universal use

Thanks to the international approval package and wide range input, the power supplies can be used worldwide.

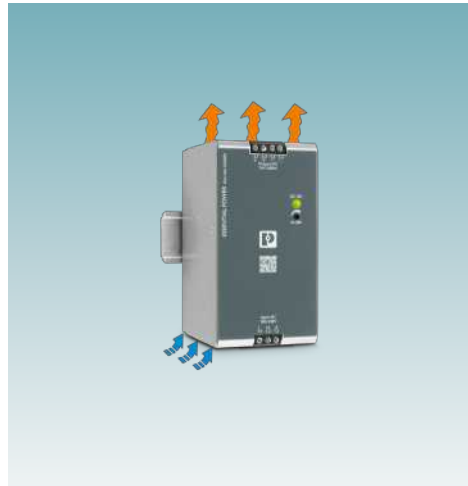

### Fanless convection cooling

The ESSENTIAL edition power supplies feature a fanless convection cooling system. This provides greater availability for your application.



### Fast installation

The preinstalled DIN rail adapter enables quick and easy installation of the device on the DIN rail.

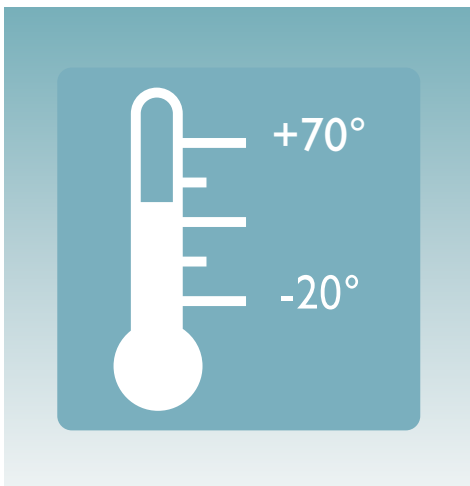

### Wide temperature range

The ESSENTIAL edition power supplies have a wide temperature range from -20°C to +70°C. Combined with built-in temperature monitoring, this ensures reliable use even in adverse temperature conditions.

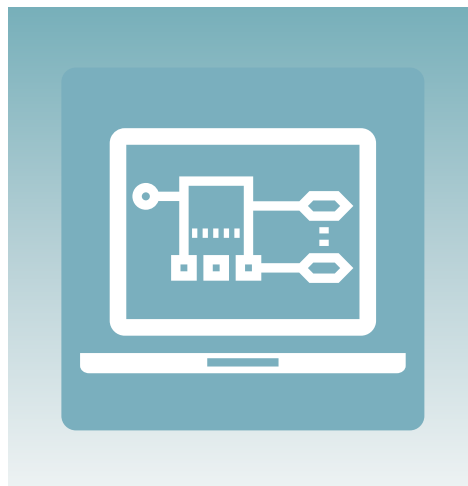

### Full data transparency

All of our device data is made available to you, from data sheets and EPLAN macros to CAD data. Our experienced support team is available to answer any outstanding queries you have.

# Power supplies

## 1-phase power supplies

### Primary-switched power supply unit, 1-phase, 24 V DC, 2.5 A, 60 W



Technical data	
Input voltage range	100 V AC ... 240 V AC -15 % ... +10 %
Current consumption (nominal load)	max. 1.5 A max. 0.6 A
Mains buffering (I <sub>N</sub> , typ.)	typ. 14 ms (120 V AC) / typ. 70 ms (230 V AC)
Nominal output voltage	24 V DC
Setting range of the output voltage	24 V DC ... 28 V DC (> 24 V DC, constant capacity restricted)
Nominal output current (I <sub>N</sub> )	max. 2.5 A
Efficiency	typ. 88 % (120 V AC) / typ. 89 % (230 V AC)
Weight / Dimensions W x H x D	270 g / 33 mm x 90 mm x 100 mm
Ambient temperature (operation)	-20 °C ... 70 °C (Derating >45°C: 2.5%/K)

Type	Item No.	Pcs./Pkt.
PS-EE-2G/1AC/24DC/60W/SC	1394764	1

### Primary-switched power supply unit, 1-phase, 24 V DC, 3.125 A, 75 W



Technical data	
Input voltage range	110 V AC ... 240 V AC ±10 % 100 V AC ... 109 V AC -15 % ... +10 %
Current consumption (nominal load)	max. 1.5 A max. 1.5 A typ. 1.3 A (110 V AC (75 W)) typ. 0.75 A (240 V AC (75 W)) typ. 1.2 A (100 V AC (63 W)) typ. 1.1 A (109 V AC (63 W))
Mains buffering (I <sub>N</sub> , typ.)	typ. 14 ms (120 V AC) / typ. 70 ms (230 V AC)
Nominal output voltage	24 V DC
Setting range of the output voltage	24 V DC ... 28 V DC (> 24 V DC, constant capacity restricted)
Nominal output current (I <sub>N</sub> )	max. 3.125 A (75 W) / max. 2.62 A (63 W)
Efficiency	typ. 88 % (120 V AC) / typ. 89 % (230 V AC)
Weight / Dimensions W x H x D	270 g / 33 mm x 90 mm x 100 mm
Ambient temperature (operation)	-20 °C ... 70 °C (Derating >45°C: 2.5%/K)

Type	Item No.	Pcs./Pkt.
PS-EE-2G/1AC/24DC/75W/SC	1234301	1

### Primary-switched power supply unit, 1-phase, 24 V DC, 5 A, 120 W



Technical data	
Input voltage range	110 V AC ... 240 V AC ±10 % 100 V AC ... 109 V AC -15 % ... +10 %
Current consumption (nominal load)	max. 2 A max. 1.5 A typ. 1.3 A (110 V AC (120 W)) typ. 0.6 A (240 V AC (120 W)) typ. 1.2 A (100 V AC (100 W)) typ. 1.1 A (109 V AC (100 W))
Mains buffering (I <sub>N</sub> , typ.)	typ. 25 ms (120 V AC) / typ. 25 ms (230 V AC)
Nominal output voltage	24 V DC
Setting range of the output voltage	24 V DC ... 28 V DC (> 24 V DC, constant capacity restricted)
Nominal output current (I <sub>N</sub> )	max. 5 A (120 W) / max. 4.16 A (100 W)
Max. power dissipation (no load/nominal load)	< 1 W (230 V AC) / < 15 W (230 V AC)
Efficiency	typ. 88 % (120 V AC) / typ. 89 % (230 V AC)
Weight / Dimensions W x H x D	600 g / 40 mm x 124 mm x 125 mm
Ambient temperature (operation)	-20 °C ... 70 °C (Derating >45°C: 2.5%/K)

Type	Item No.	Pcs./Pkt.
PS-EE-2G/1AC/24DC/120W/SC	1234302	1

### Primary-switched power supply unit, 1-phase, 24 V DC, 10 A, 240 W



Technical data	
Input voltage range	110 V AC ... 240 V AC ±10 % 100 V AC ... 109 V AC -15 % ... +10 %
Current consumption (nominal load)	max. 3 A max. 2.5 A typ. 2.4 A (110 V AC (240 W)) typ. 1.2 A (240 V AC (240 W)) typ. 2.4 A (100 V AC (200 W)) typ. 2.3 A (109 V AC (200 W))
Mains buffering (I <sub>N</sub> , typ.)	typ. 30 ms (120 V AC) / typ. 30 ms (230 V AC)
Nominal output voltage	24 V DC
Setting range of the output voltage	24 V DC ... 28 V DC (> 24 V DC, constant capacity restricted)
Nominal output current (I <sub>N</sub> )	max. 10 A (240 W) / max. 8.33 A (200 W)
Efficiency	typ. 91 % (120 V AC) / typ. 92 % (230 V AC)
Weight / Dimensions W x H x D	940 g / 60 mm x 124 mm x 125 mm
Ambient temperature (operation)	-20 °C ... 70 °C (Derating >45°C: 2.5%/K)

Type	Item No.	Pcs./Pkt.
PS-EE-2G/1AC/24DC/240W/SC	1234304	1

**Primary-switched power supply unit, 1-phase, 24 V DC, 20 A, 480 W**



Technical data	
Input voltage range	110 V AC ... 240 V AC $\pm 10\%$ 100 V AC ... 109 V AC -15 % ... +10 %
Current consumption (nominal load)	max. 6 A max. 5 A typ. 5 A (110 V AC (480 W)) typ. 2.3 A (240 V AC (480 W)) typ. 4.5 A (100 V AC (400 W)) typ. 4.3 A (109 V AC (400 W))
Mains buffering ( $I_N$ , typ.)	typ. 15 ms (120 V AC) / typ. 35 ms (230 V AC)
Nominal output voltage	24 V DC
Setting range of the output voltage	24 V DC ... 28 V DC (> 24 V DC, constant capacity restricted)
Nominal output current ( $I_N$ )	max. 20 A (480 W) / max. 16.66 A (400 W)
Efficiency	typ. 91 % (120 V AC) / typ. 93 % (230 V AC)
Weight / Dimensions W x H x D	1.4 kg / 86 mm x 124 mm x 125 mm
Ambient temperature (operation)	-20 °C ... 70 °C (Derating >45°C: 2.5%/K)

Type	Item No.	Pcs./Pkt.
PS-EE-2G/1AC/24DC/480W/SC	1234308	1



# Power supplies

## 3-phase power supplies

### Primary-switched power supply unit, 3-phase, 24 V DC, 10 A, 240 W

Primary-switched ESSENTIAL edition power supply for DIN rail mounting, input: 3-phase, output: 24 V DC / 240 W



Technical data	
Certification	EN
Input voltage range	3x 320 V AC ... 575 V AC
Current consumption (nominal load)	3x 0.6 A (400 V AC) / 3x 0.5 A (480 V AC)
Mains buffering ( $I_N$ , typ.)	> 20 ms (3x 400 V AC)
Nominal output voltage	24 V DC $\pm 1$ %
Setting range of the output voltage	22.5 V DC ... 29.5 V DC (> 24 V DC, constant capacity restricted)
Nominal output current ( $I_N$ )	10 A ( $U_{OUT} = 24$ V DC)
Efficiency	88.5 % (at 400 V AC and nominal values)
Weight / Dimensions W x H x D	1.1 kg / 60 mm x 130 mm x 152.5 mm
Ambient temperature (operation)	-25 °C ... 70 °C (> 55 °C Derating: 2.5 %/K)

Type	Item No.	Pcs./Pkt.
ESSENTIAL-PS/3AC/24DC/240W/EE	1018291	1

### Primary-switched power supply unit, 3-phase, 24 V DC, 20 A, 480 W

Primary-switched ESSENTIAL edition power supply for DIN rail mounting, input: 3-phase, output: 24 V DC / 480 W



Technical data	
Certification	EN
Input voltage range	3x 320 V AC ... 575 V AC
Current consumption (nominal load)	3x 1.1 A (400 V AC) / 3x 0.8 A (480 V AC)
Mains buffering ( $I_N$ , typ.)	> 17 ms (3x 400 V AC)
Nominal output voltage	24 V DC $\pm 1$ %
Setting range of the output voltage	22.5 V DC ... 29.5 V DC (> 24 V DC, constant capacity restricted)
Nominal output current ( $I_N$ )	20 A ( $U_{OUT} = 24$ V DC)
Efficiency	91 % (at 400 V AC and nominal values)
Weight / Dimensions W x H x D	2 kg / 115 mm x 130 mm x 152.5 mm
Ambient temperature (operation)	-25 °C ... 70 °C (> 55 °C Derating: 2.5 %/K)

Type	Item No.	Pcs./Pkt.
ESSENTIAL-PS/3AC/24DC/480W/EE	1018299	1

### Primary-switched power supply unit, 3-phase, 24 V DC, 40 A, 960 W

Primary-switched ESSENTIAL edition power supply for DIN rail mounting, input: 3-phase, output: 24 V DC / 960 W



Technical data	
Certification	EN
Input voltage range	3x 320 V AC ... 575 V AC
Current consumption (nominal load)	3x 2 A (400 V AC) / 3x 1.6 A (480 V AC)
Mains buffering ( $I_N$ , typ.)	> 16 ms (3x 400 V AC)
Nominal output voltage	24 V DC $\pm 1$ %
Setting range of the output voltage	22.5 V DC ... 29.5 V DC (> 24 V DC, constant capacity restricted)
Nominal output current ( $I_N$ )	40 A ( $U_{OUT} = 24$ V DC)
Efficiency	91.5 % (at 400 V AC and nominal values)
Weight / Dimensions W x H x D	3.2 kg / 139 mm x 130 mm x 190 mm
Ambient temperature (operation)	-25 °C ... 70 °C (> 55 °C Derating: 2.5 %/K)

Type	Item No.	Pcs./Pkt.
ESSENTIAL-PS/3AC/24DC/960W/EE	1018294	1



# Relay modules



## Relay modules

In the industrial control process, there needs to be a product between the control system and the devices on site that provides reliable switchover control. With ESSENTIAL edition control relays from Phoenix Contact, various relay solutions can be constructed flexibly according to on-site needs.

## Product range overview

Industrial relay system with basic functionality – ECOR-1	<b>66</b>
Industrial relay system with basic functionality – ECOR-2	<b>69</b>
Industrial relay system with basic functionality - ECOR-4	<b>72</b>
Accessories for relay bases	<b>74</b>

Efficient and modular

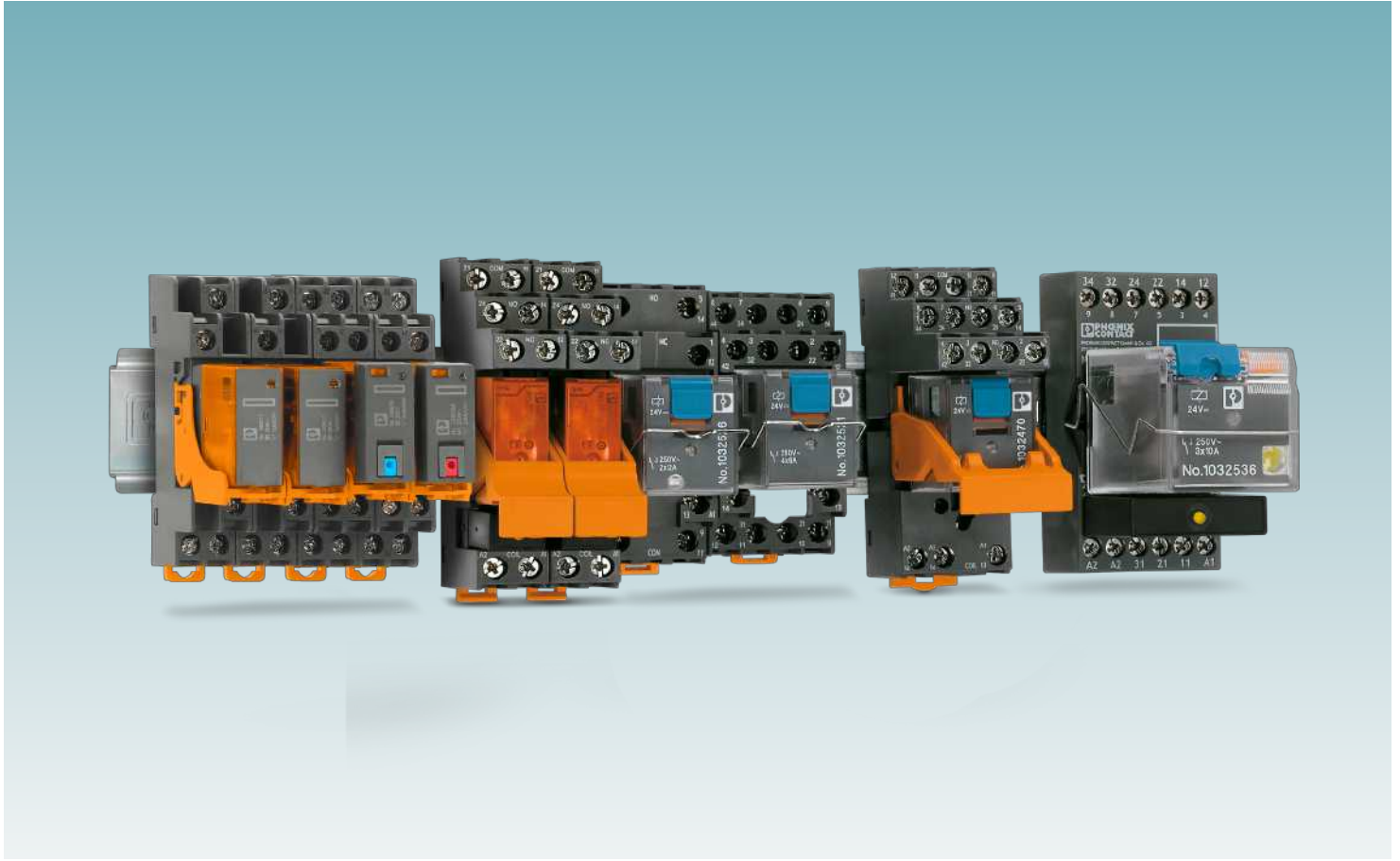

ESSENTIAL edition is an efficient, modular industrial relay system with basic functions, consisting of relays, relay bases, retaining brackets, and plug-in function modules. Take advantage of a flexible range with one to four changeover contacts and input voltages of 12 V DC to 230 V AC.

From product development to series production – the high quality of Phoenix Contact products is assured through consistent testing in accordance with uniform directives and in-house standards.

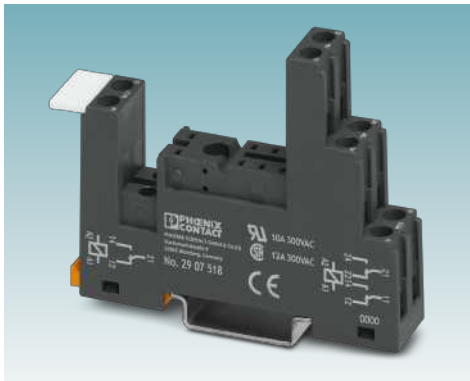

**ECOR-1**

The 16 mm narrow ECOR-1 base series with screw connection is suitable for miniature power relays and miniature switching relays with one or two changeover contacts. Currents up to 12 A can be switched. Relay bases are available with a bolt connection.



**ECOR-2**

The ECOR-2 base series is suitable for industrial relays with two or four changeover contacts. Currents up to 12 A are no problem for these bases. Relay bases are available either with screw connection or bolt connection. In addition, a width-optimized ECOR-2 base with plugging capabilities for input / interference suppression modules is available for industrial relays with two changeover contacts.



**ECOR-4**

The 44 mm wide ECOR-4 base series is ideal for power relays with four FASTON contacts. Switching currents up to 10 A can be implemented here. The relay bases are available as a bolt connection with screw connection input/interference suppression modules.



### 100 % tested

Securing high product quality with 100 % testing of isolation and function.

Additional type tests:

- Dielectric test
- Function test

The following type tests are also performed:

- Conductor pull-out test
- Dielectric test
- Temperature increase test

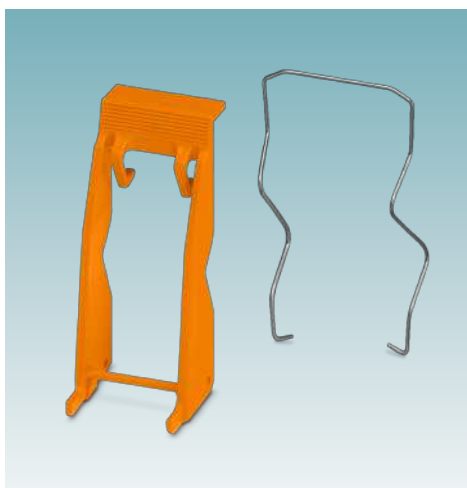

### Reliable system for high machine and system availability

Plastic relay retaining bracket with eject function and metal relay retaining bracket



### Plug-in modules

Function plug-in modules for coil suppression and status display.



### ECOR-1 FASTON relay

With the ECOR-1 FASTON relay in 1CO & 2CO contact type available with or without manual actuation in various voltage versions, Phoenix Contact offers solutions for industrial areas that require robustness and a space-saving design.



### Easy wiring

Easy wiring with screw connection. Also with ferrules or bold connection available.

### Your advantages:

- ✓ High cost efficiency
- ✓ Relays from 1 to 4 changeover contacts
- ✓ Robust bolt connection technology
- ✓ UL and CSA approval

# Relay modules

## Industrial relay system with basic functionality – ECOR-1

### Relay base, ECOR-1

ECOR-1... relay base, for miniature power relays or miniature switching relays with 1 or 2 changeover contacts, bolt connection, for mounting on NS 35/7,5.



Technical data	
Nominal voltage $U_N$	230 V AC/DC
Nominal current at $U_N$	10 A
Ambient temperature (operation)	-25 °C ... 55 °C
Connection method	Bolt connection
Connection cross section (solid / stranded / AWG)	0.2 - 2.5 mm <sup>2</sup> / 0.2 - 2.5 mm <sup>2</sup> / - 14
Dimensions	
Width	15.8 mm
Depth with retaining bracket	58.1 mm
Height	71.5 mm

Type	Item No.	Pcs./Pkt.
ECOR-1-BSC2-RT/2X21	1027546	10

Accessories	Type	Item No.	Pcs./Pkt.
Relay retaining bracket, Plastic	ECOR-RH-1L	2907524	10
Equipment marker, labeling surface 6 x 15 mm	MP 1	2833631	10

### Relay base, ECOR-1

ECOR-1... relay base, for miniature power relay or miniature switching relay with 1 or 2 changeover contacts, screw connection, plug-in option for input/interference suppression modules, for mounting on NS 35/7,5



Technical data	
Nominal voltage $U_N$	250 V AC/DC
Nominal current at $U_N$	12 A
Ambient temperature (operation)	-25 °C ... 70 °C
Connection method	Screw connection
Connection cross section (solid / stranded / AWG)	0.2 - 2.5 mm <sup>2</sup> / 0.2 - 2.5 mm <sup>2</sup> / -
Dimensions	
Width	15.7 mm
Depth with retaining bracket	69 mm / 78 mm
Height	79.2 mm

Type	Item No.	Pcs./Pkt.
ECOR-1-BSC3/2X21	2907518	10

Accessories	Type	Item No.	Pcs./Pkt.
Relay retaining bracket, Plastic	ECOR-RH-1L	2907524	10
Plug-in module for relay bases, Plug-in module	LDP- 12- 24DC	2833657	10
Plug-in module for relay bases, Plug-in module	DP-12-220 DC	2907517	10
Plug-in module for relay bases, Plug-in module	LV-120-230AC/110DC	2833738	10
Plug-in module for relay bases, Plug-in module	V-120-230UC	2833880	10
Plug-in module for relay bases, Plug-in module	RC-120-230UC	2833767	10
Equipment marker, labeling surface 6 x 15 mm	MP 1	2833631	10



### Single relay, Miniature relay, 1 changeover contact

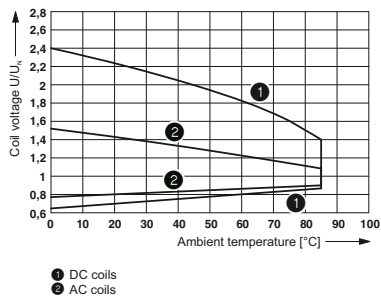

#### Common technical data

Permissible range (with reference to $U_N$ )	See diagram
Typ. response time at $U_N$	8 ms
Typ. release time at $U_N$	6 ms
Contact type	1 changeover contact
Contact material	AgNi
Max. switching voltage	250 V AC/DC
Min. switching voltage	5 V (At 24 mA)
Limiting continuous current	16 A
Max. inrush current	30 A (300 ms)
Min. switching current	10 mA (at 12 V)
Mechanical service life	$1 \times 10^7$ cycles
Ambient temperature (operation)	-40 °C ... 85 °C
Standards/specifications	IEC 60664 ; EN 61810-1

Input voltage $U_N$	Typ. input current at $U_N$	Type	Item No.	Pcs./Pkt.
12 V DC	33.3 mA	REL-MR-BL- 12DC/21HC	1109537	20
24 V DC	17 mA	REL-MR-BL- 24DC/21HC	2906285	20
48 V DC	8.4 mA	REL-MR-BL- 48DC/21HC	1109538	20
110 V DC	3.8 mA	REL-MR-BL-110DC/21HC	1109539	20

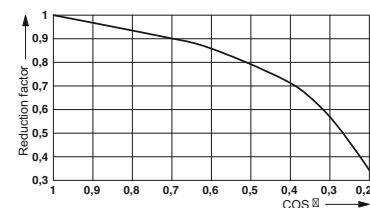
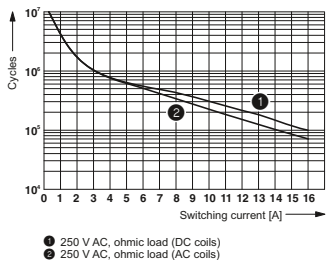

Electrical service life

Service life reduction factor with various cos phi

### Single relay, Miniature relay, 1 changeover contact

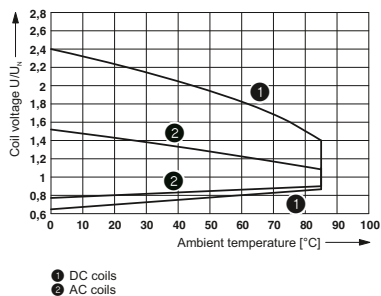

#### Common technical data

Permissible range (with reference to $U_N$ )	See diagram
Typ. response time at $U_N$	3 ms ... 12 ms (depending on phase relation)
Typ. release time at $U_N$	2 ms ... 9 ms (depending on phase relation)
Contact type	1 changeover contact
Contact material	AgNi
Max. switching voltage	250 V AC/DC
Min. switching voltage	5 V (At 24 mA)
Limiting continuous current	16 A
Max. inrush current	30 A (300 ms)
Min. switching current	10 mA (at 12 V)
Mechanical service life	$1 \times 10^7$ cycles
Ambient temperature (operation)	-40 °C ... 70 °C
Standards/specifications	IEC 60664 ; EN 61810-1

Input voltage $U_N$	Typ. input current at $U_N$	Type	Item No.	Pcs./Pkt.
24 V AC	31.6 mA	REL-MR-BL- 24AC/21HC	1109540	20
115 V AC	6.6 mA	REL-MR-BL-115AC/21HC	1109542	20
230 V AC	3 mA	REL-MR-BL-230AC/21HC	2906288	20

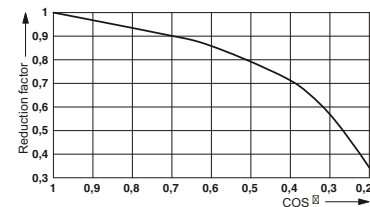
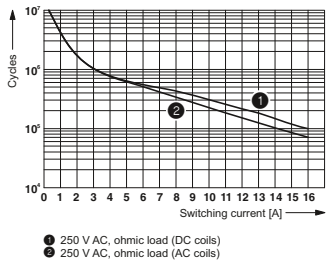

Electrical service life

Service life reduction factor with various cos phi

# Relay modules

## Industrial relay system with basic functionality – ECOR-1

### Single relay, Miniature relay, 2 changeover contacts

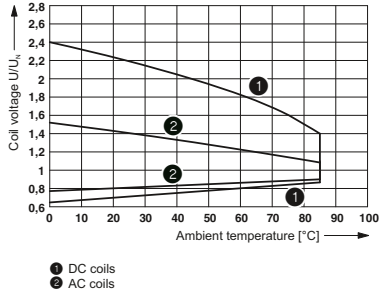

#### Common technical data

Permissible range (with reference to $U_N$ )	See diagram
Typ. response time at $U_N$	8 ms
Typ. release time at $U_N$	6 ms
Contact type	2 changeover contacts
Contact material	AgNi
Max. switching voltage	250 V AC/DC
Min. switching voltage	5 V (at 10 mA)
Limiting continuous current	8 A
Max. inrush current	12 A (20 ms)
Min. switching current	10 mA (At 5 V)
Mechanical service life	$3 \times 10^7$ cycles
Ambient temperature (operation)	$-40^{\circ}\text{C} \dots 85^{\circ}\text{C}$
Standards/specifications	IEC 60664 ; EN 61810-1

Input voltage $U_N$	Typ. input current at $U_N$	Type	Item No.	Pcs./Pkt.
12 V DC	33.3 mA	REL-MR-BL- 12DC/21-21	1109543	20
24 V DC	17 mA	REL-MR-BL- 24DC/21-21	2906286	20
48 V DC	8.7 mA	REL-MR-BL- 48DC/21-21	1109544	20
110 V DC	3.8 mA	REL-MR-BL-110DC/21-21	1109545	20

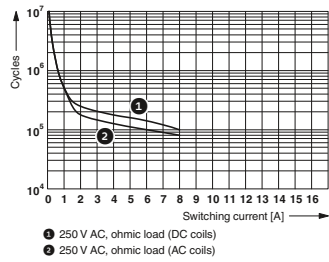

Electrical service life

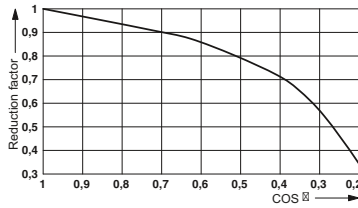

Service life reduction factor with various cos phi

### Single relay, Miniature relay, 2 changeover contacts

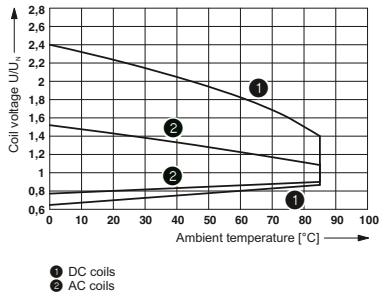

#### Common technical data

Permissible range (with reference to $U_N$ )	See diagram
Typ. response time at $U_N$	3 ms ... 12 ms (depending on phase relation)
Typ. release time at $U_N$	2 ms ... 9 ms (depending on phase relation)
Contact type	2 changeover contacts
Contact material	AgNi
Max. switching voltage	250 V AC/DC
Min. switching voltage	5 V (at 10 mA)
Limiting continuous current	8 A
Max. inrush current	12 A (20 ms)
Min. switching current	10 mA (At 5 V)
Mechanical service life	$5 \times 10^6$ cycles
Ambient temperature (operation)	$-40^{\circ}\text{C} \dots 70^{\circ}\text{C}$
Standards/specifications	IEC 60664 ; EN 61810-1

Input voltage $U_N$	Typ. input current at $U_N$	Type	Item No.	Pcs./Pkt.
24 V AC	31.6 mA	REL-MR-BL- 24AC/21-21	1109546	20
115 V AC	6.6 mA	REL-MR-BL-115AC/21-21	1109569	20
230 V AC	3 mA	REL-MR-BL-230AC/21-21	2906287	20

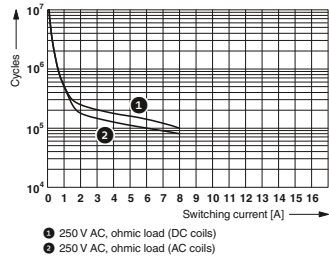

Electrical service life

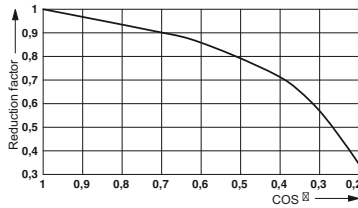

Service life reduction factor with various cos phi

### Relay base, ECOR-2

ECOR-2 relay base, for industrial relays with two changeover contacts, bolt connection, for mounting on NS 35/7,5



Technical data	
Nominal voltage $U_N$	250 V AC/DC
Nominal current at $U_N$	12 A
Ambient temperature (operation)	-25 °C ... 55 °C
Connection method	Bolt connection
Connection cross section (solid / stranded / AWG)	0.2 - 2.5 mm <sup>2</sup> / 0.2 - 2.5 mm <sup>2</sup> / -
Dimensions	
Width	25 mm
Depth with retaining bracket	63 mm
Height	68.5 mm

Type	Item No.	Pcs./Pkt.
ECOR-2-BSC2-RT/2X21	2908341	10

Accessories		Type	Item No.	Pcs./Pkt.
Relay retaining bracket, Plastic		ECOR-RH-2L	1051972	10
Relay retaining bracket, Metal		ECOR-RHM-2L	1047026	10

### Single relay, Industrial relay, 2 changeover contacts

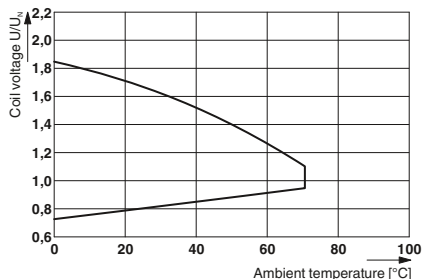

Common technical data	
Permissible range (with reference to $U_N$ )	See diagram
Typ. response time at $U_N$	15 ms
Typ. release time at $U_N$	10 ms
Contact type	2 changeover contacts
Contact material	AgNi
Max. switching voltage	250 V AC/DC
Min. switching voltage	12 V (10 mA)
Limiting continuous current	12 A
Max. inrush current	24 A (20 ms, N/O contacts)
Min. switching current	10 mA (12 V)
Mechanical service life	3x 10 <sup>7</sup> cycles
Ambient temperature (operation)	-40 °C ... 70 °C
Standards/specifications	EN 61810-1

Input voltage $U_N$	Typ. input current at $U_N$	Status indication	Type	Item No.	Pcs./Pkt.
12 V DC	63 mA	Yellow LED	REL-IR-BL/L- 12DC/2X21	1109547	10
24 V DC	31 mA	-	REL-IR-BL- 24DC/2X21	1032470	10
24 V DC	32 mA	Yellow LED (bidirectional)	REL-IR-BL/L- 24DC/2X21	1032526	10
48 V DC	16 mA	Yellow LED	REL-IR-BL/L- 48DC/2X21	1109548	10
110 V DC	6.9 mA	Yellow LED	REL-IR-BL/L-110DC/2X21	1109550	10
125 V DC	6.1 mA	Yellow LED	REL-IR-BL/L-125DC/2X21	1109553	10

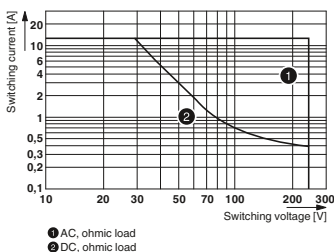

Interrupting rating

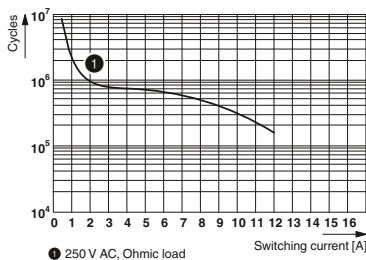

Electrical service life

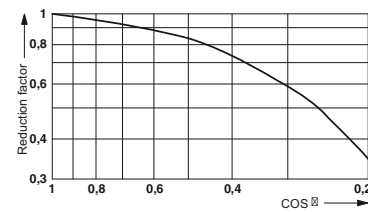

Service life reduction factor

# Relay modules

## Industrial relay system with basic functionality – ECOR-2

### Single relay, Industrial relay, 2 changeover contacts

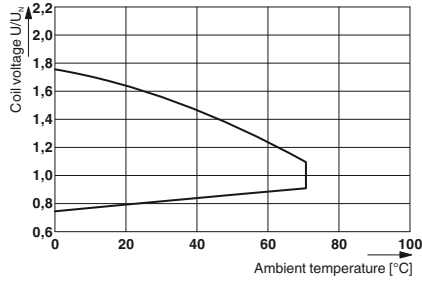

#### Common technical data

Permissible range (with reference to U <sub>N</sub> )	See diagram
Typ. response time at U <sub>N</sub>	5 ms ... 15 ms
Typ. release time at U <sub>N</sub>	5 ms ... 20 ms
Contact type	2 changeover contacts
Contact material	AgNi
Max. switching voltage	250 V AC/DC
Min. switching voltage	12 V (10 mA)
Limiting continuous current	12 A
Max. inrush current	24 A (20 ms, N/O contacts)
Min. switching current	10 mA (12 V)
Mechanical service life	2x 10 <sup>7</sup> cycles
Ambient temperature (operation)	-40 °C ... 70 °C
Standards/specifications	EN 61810-1

Input voltage U <sub>N</sub>	Typ. input current at U <sub>N</sub>	Status indication	Type	Item No.	Pcs./Pkt.
24 V AC	45 mA	Yellow LED	REL-IR-BL/L- 24AC/2X21	1109555	10
115 V AC	9.2 mA	Yellow LED	REL-IR-BL/L-115AC/2X21	1109556	10
230 V AC	4.4 mA (50 Hz)	Yellow LED	REL-IR-BL/L-230AC/2X21	1032530	10
230 V AC	4.4 mA (50 Hz)	-	REL-IR-BL-230AC/2X21	1032528	10

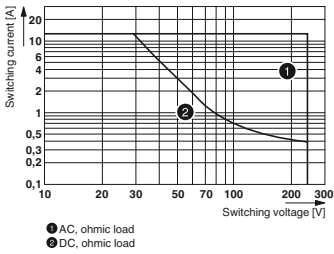

Interrupting rating

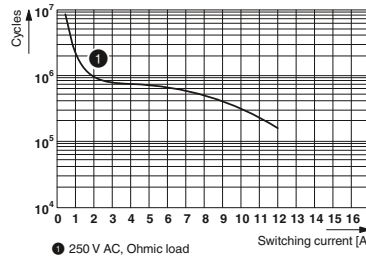

Electrical service life

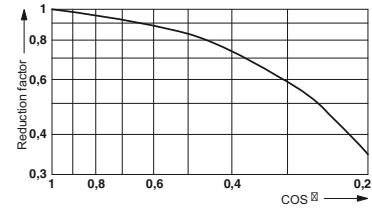

Service life reduction factor

### Relay base, ECOR-2

ECOR-2 relay base, for industrial relays with four changeover contacts, bolt connection, for mounting on NS 35/7,5



#### Technical data

Nominal voltage U <sub>N</sub>	250 V AC/DC
Nominal current at U <sub>N</sub>	5 A
Ambient temperature (operation)	-25 °C ... 55 °C
Connection method	Bolt connection
Connection cross section (solid / stranded / AWG)	0.2 - 2.5 mm <sup>2</sup> / 0.2 - 2.5 mm <sup>2</sup> / -
<b>Dimensions</b>	
Width	29.8 mm
Depth with retaining bracket	63 mm
Height	64.9 mm

	Type	Item No.	Pcs./Pkt.
	ECOR-2-BSC2-RT/4X21	2908214	10
<b>Accessories</b>			
Relay retaining bracket, Plastic	ECOR-RH-2L	1051972	10
Relay retaining bracket, Metal	ECOR-RHM-2L	1047026	10

### Relay base, ECOR-2

ECOR-2 relay base, for industrial relay with 2 or 4 changeover contacts, screw connection, plug-in option for input/interference suppression modules, for mounting on NS 35/7,5



Technical data	
Nominal voltage $U_N$	300 V AC/DC
Nominal current at $U_N$	12 A
Ambient temperature (operation)	-25 °C ... 85 °C
Connection method	Screw connection
Connection cross section (solid / stranded / AWG)	0.2 - 2.5 mm <sup>2</sup> / 0.2 - 2.5 mm <sup>2</sup> / -
Dimensions	
Width	27 mm
Depth with retaining bracket	86 mm
Height	78.5 mm

Type	Item No.	Pcs./Pkt.
ECOR-2-BSC3/4X21	2907521	10

Accessories		Type	Item No.	Pcs./Pkt.
Relay retaining bracket, Plastic		ECOR-RH-2L	1051972	10
Relay retaining bracket, Metal		ECOR-RHM-2L	1047026	10
Plug-in module for relay bases, Plug-in module		LDP- 12- 24DC	2833657	10
Plug-in module for relay bases, Plug-in module		DP-12-220 DC	2907517	10
Plug-in module for relay bases, Plug-in module		LV-120-230AC/110DC	2833738	10
Plug-in module for relay bases, Plug-in module		V-120-230UC	2833880	10
Plug-in module for relay bases, Plug-in module		RC-120-230UC	2833767	10
Equipment marker, labeling surface 9 x 25 mm		MP 2	2833644	10

### Single relay, Industrial relay, 4 changeover contacts

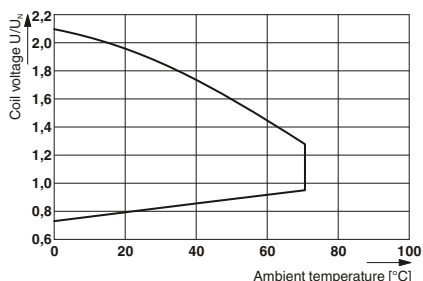

Common technical data	
Permissible range (with reference to $U_N$ )	See diagram
Typ. response time at $U_N$	15 ms
Typ. release time at $U_N$	10 ms
Contact type	4 changeover contacts
Contact material	AgNi
Max. switching voltage	250 V AC/DC
Min. switching voltage	12 V (10 mA)
Limiting continuous current	6 A
Max. inrush current	12 A (20 ms, N/O contacts)
Min. switching current	10 mA (12 V)
Mechanical service life	3x 10 <sup>7</sup> cycles
Ambient temperature (operation)	-40 °C ... 70 °C
Standards/specifications	EN 61810-1

Input voltage $U_N$	Typ. input current at $U_N$	Status indication	Type	Item No.	Pcs./Pkt.
12 V DC	63 mA	Yellow LED	REL-IR-BL/L- 12DC/4X21	1109557	10
24 V DC	31 mA	-	REL-IR-BL- 24DC/4X21	1032521	10
24 V DC	32 mA	Yellow LED (bidirectional)	REL-IR-BL/L- 24DC/4X21	1032527	10
48 V DC	16 mA	Yellow LED	REL-IR-BL/L- 48DC/4X21	1109558	10
110 V DC	6.9 mA	Yellow LED	REL-IR-BL/L-110DC/4X21	1109560	10
125 V DC	6.1 mA	Yellow LED	REL-IR-BL/L-125DC/4X21	1109561	10

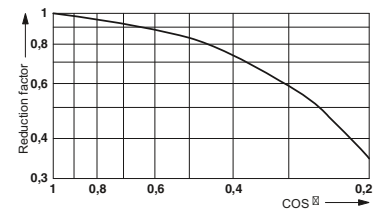
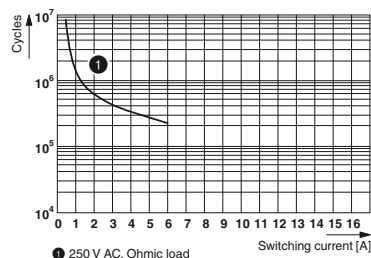
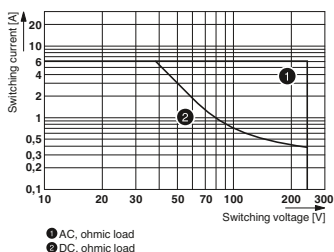

Interrupting rating

Electrical service life

Service life reduction factor

# Relay modules

## Industrial relay system with basic functionality – ECOR-2

### Single relay, Industrial relay, 4 changeover contacts

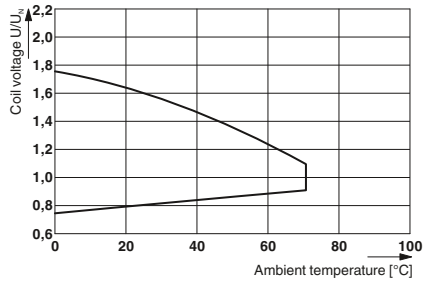

#### Common technical data

Permissible range (with reference to U <sub>N</sub> )	See diagram
Typ. response time at U <sub>N</sub>	5 ms ... 15 ms
Typ. release time at U <sub>N</sub>	5 ms ... 20 ms
Contact type	4 changeover contacts
Contact material	AgNi
Max. switching voltage	250 V AC/DC
Min. switching voltage	12 V (10 mA)
Limiting continuous current	6 A
Max. inrush current	12 A (20 ms, N/O contacts)
Min. switching current	10 mA (12 V)
Mechanical service life	2x 10 <sup>7</sup> cycles
Ambient temperature (operation)	-40 °C ... 70 °C
Standards/specifications	EN 61810-1

Input voltage U <sub>N</sub>	Typ. input current at U <sub>N</sub>	Status indication	Type	Item No.	Pcs./Pkt.
24 V AC	45 mA (50 Hz)	Yellow LED	REL-IR-BL/L- 24AC/4X21	1109563	10
115 V AC	9.2 mA (50 Hz)	Yellow LED	REL-IR-BL/L-115AC/4X21	1109564	10
230 V AC	4.4 mA (50 Hz)	Yellow LED	REL-IR-BL/L-230AC/4X21	1032531	10
230 V AC	4.4 mA (50 Hz)	-	REL-IR-BL-230AC/4X21	1032529	10

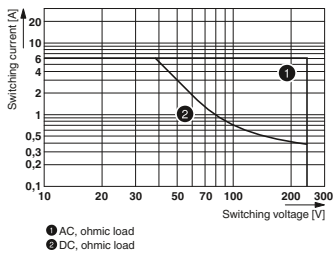

Interrupting rating

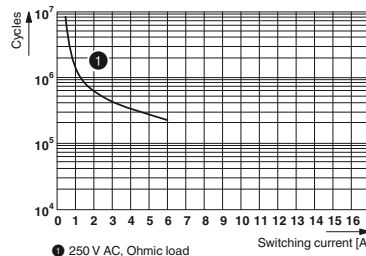

Electrical service life

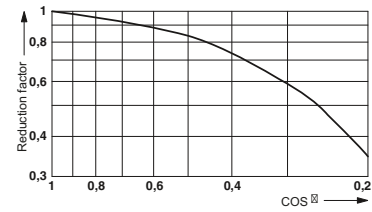

Service life reduction factor

### Relay base, ECOR-4

ECOR-4 relay base, for power relay with 4 changeover contacts, ring cable lug screw connection, for mounting on NS 35/7.5



#### Technical data

Input voltage U <sub>N</sub>	≤ 230 V AC/DC
Ambient temperature (operation)	-40 °C ... 85 °C
Connection method	Screw connection
Connection cross section (solid / stranded / AWG)	0.5 - 2.5 mm <sup>2</sup> / 0.5 - 2.5 mm <sup>2</sup> / -
<b>Dimensions</b>	
Width	44.1 mm
Depth with retaining bracket	30 mm
Height	83.3 mm

Type	Item No.	Pcs./Pkt.
ECOR-4-BSC2/4X21	1157947	10

Accessories	Type	Item No.	Pcs./Pkt.
Relay retaining bracket	ECOR-RHM-4	1289771	10

### Single relay, 4 changeover contacts

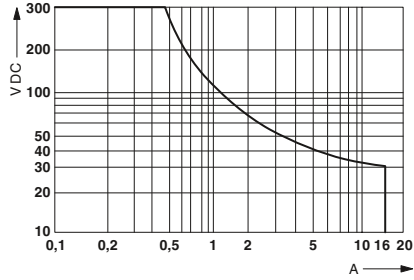

#### Common technical data

Permissible range (with reference to $U_N$ )	See diagram
Status indication	Green LED
Typ. response time at $U_N$	$\leq 20$ ms
Typ. release time at $U_N$	$\leq 20$ ms
Contact type	4 changeover contacts
Contact material	AgSnO
Max. switching voltage	250 V AC/DC
Min. switching voltage	17 V (10 mA)
Limiting continuous current	10 A
Min. switching current	10 mA (17 V)
Mechanical service life	approx. $10^7$ cycles
Ambient temperature (operation)	-25 °C ... 55 °C
Standards/specifications	EN 61810

Input voltage $U_N$	Typ. input current at $U_N$	Type	Item No.	Pcs./Pkt.
24 V DC	67 mA	REL-PR-BL- 24DC/4X21	1157980	10
110 V DC	19.8 mA	REL-PR-BL-110DC/4X21	1157976	10
125 V DC	17.3 mA	REL-PR-BL-125DC/4X21	1157973	10
220 V DC	9.6 mA	REL-PR-BL-220DC/4X21	1157968	10

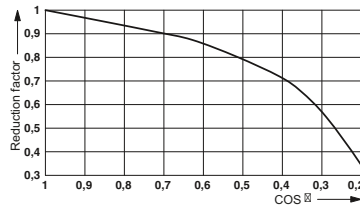
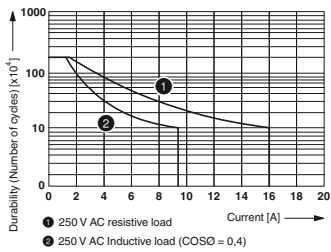

Electrical service life

Service life reduction factor

### Single relay, 4 changeover contacts

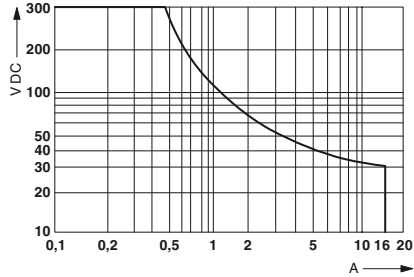

#### Common technical data

Permissible range (with reference to $U_N$ )	See diagram
Status indication	Green LED
Typ. response time at $U_N$	$\leq 20$ ms (depending on phase relation)
Typ. release time at $U_N$	$\leq 20$ ms (depending on phase relation)
Contact type	4 changeover contacts
Contact material	AgSnO
Max. switching voltage	250 V AC/DC
Min. switching voltage	17 V (10 mA)
Limiting continuous current	10 A
Min. switching current	10 mA (17 V)
Mechanical service life	approx. $10^7$ cycles
Ambient temperature (operation)	-25 °C ... 55 °C
Standards/specifications	EN 61810

Input voltage $U_N$	Typ. input current at $U_N$	Type	Item No.	Pcs./Pkt.
24 V AC	2.3 mA (50 Hz)	REL-PR-BL-24AC/4X21	1157979	10
115 V AC	3 mA (50 Hz)	REL-PR-BL-115AC/4X21	1157971	10
230 V AC	2.5 mA (50 Hz)	REL-PR-BL-230VAC/4X21	1157966	10

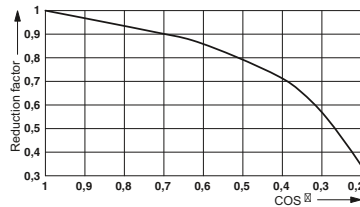
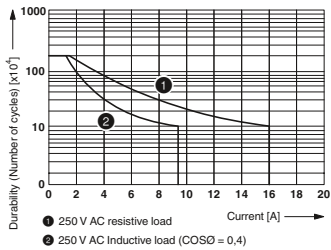

Electrical service life

Service life reduction factor



# Relay modules

## Accessories for relay bases

### Plug-in module for relay bases, Plug-in module

Plug-in module, with freewheeling diode and yellow LED, polarity: A1+, A2-, input voltage: 12 ... 24 V DC  $\pm 20\%$

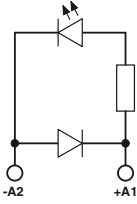

Technical data	
Input voltage $U_N$	12 V DC ... 24 V DC
Protective circuit	Freewheeling diode, LED

Type	Item No.	Pcs./Pkt.
LDP- 12- 24DC	2833657	10

### Plug-in module for relay bases, Plug-in module

Plug-in module, with freewheeling diode, polarity: A1+, A2-, input voltage: 12 V DC ... 220 V DC  $\pm 20\%$



Technical data	
Input voltage $U_N$	12 V DC ... 220 V DC
Protective circuit	Freewheeling diode

Type	Item No.	Pcs./Pkt.
DP-12-220 DC	2907517	10

### Plug-in module for relay bases, Plug-in module

Plug-in module, with varistor and yellow LED, input voltage: 120 ... 230 V AC / 110 V DC  $\pm 20\%$

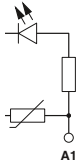

Technical data	
Input voltage $U_N$	120 V AC ... 230 V AC
Protective circuit	Varistor, LED

Type	Item No.	Pcs./Pkt.
LV-120-230AC/110DC	2833738	10

### Plug-in module for relay bases, Plug-in module

Plug-in module, with varistor, input voltage: 120 ... 230 V AC/DC  $\pm 20\%$



Technical data	
Input voltage $U_N$	120 V AC/DC ... 230 V AC/DC
Protective circuit	Varistor

Type	Item No.	Pcs./Pkt.
V-120-230UC	2833880	10

**Plug-in module for relay bases, Plug-in module**

Plug-in module, with RC element, input voltage: 120 ... 230 V AC/DC  $\pm 20\%$

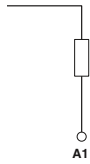

**Technical data**

Input voltage $U_N$	120 V AC/DC ... 230 V AC/DC
Protective circuit	RC element

<b>Type</b>	<b>Item No.</b>	<b>Pcs./Pkt.</b>
RC-120-230UC	2833767	10

**Plug-in module for relay bases, Plug-in module**

Plug-in module, for mounting on PR3, with damping diode and yellow LED, polarity: **A1+**, **A2-**, input voltage: 48 ... 60 V DC  $\pm 20\%$

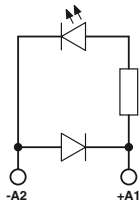

**Technical data**

Input voltage $U_N$	48 V DC ... 60 V DC
---------------------	---------------------

<b>Type</b>	<b>Item No.</b>	<b>Pcs./Pkt.</b>
LDP3- 48- 60DC	2833783	10

# Timer and monitoring relays



### Timer and monitoring relays

Timer relays are easy to use, feature various functions, and can be used as a complete and cost-effective application for timing control. To safeguard the reliable operation of devices and systems, the monitoring relays can detect grid and voltage failures in good time.

## Product range overview

Compact time relays with basic functionality	<b>80</b>
Compact monitoring relays with basic functionality	<b>81</b>

### Universal and space-saving

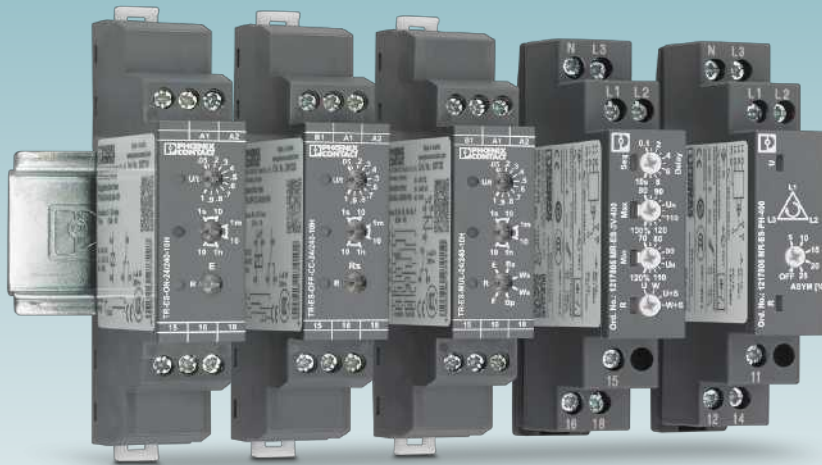

Compact timer relays in a 17.5 mm wide housing for controlling time sequences. Single-function timer relays, multi-functional timer relays, and monitoring relays are suitable for most universal requirements. The ESSENTIAL edition timer relays can be used as an efficient application for many time delay tasks. The ESSENTIAL edition monitoring relays quickly recognize deviations from key system parameters. They report these deviations or shut system parts down selectively.

#### Your advantages:

- ✓ Easy to select, thanks to just 3 articles which can satisfy most universal time delay tasks
- ✓ Optimum time control with setting range from milliseconds to 10 hours
- ✓ Monitoring relay ideally suited for simple monitoring tasks
- ✓ Easy handling, as time parameters can be adjusted conveniently on the front of the housing
- ✓ Space saving, thanks to a compact housing
- ✓ CCC approval



### Find the right product quickly

With switch-on delay, switch-off delay or multifunctional: available in just three versions, they cover all applications associated with conventional time control.

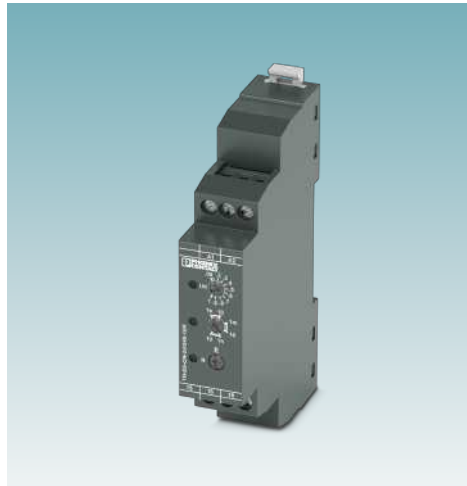

### Space-saving

Thanks to the compact installation housing, they are ideally suited for building installation. As reasonably priced solutions with numerous functions, the products are just as ideally suited for series production.

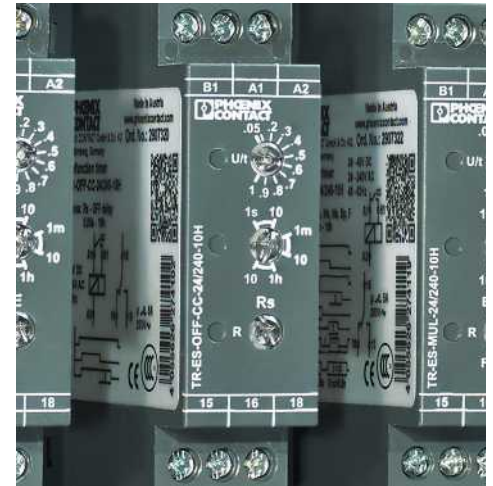

### Simple operation

Parameters can be set conveniently via the rotary switch on the front of the housing. The time relays feature a precise setting range of milliseconds to up to 10 hours.



### Three-phase voltage monitoring relays

The ESSENTIAL edition MR-ES series voltage monitoring relays can detect grid and voltage failures early enough to safeguard the reliable operation of devices and systems. You can select between two device types: Voltage or phase monitoring.

# Timer and monitoring relays

## Compact time relays with basic functionality

### Timer relay

Timer relay with delay release breakover function and an adjustable time range (50 ms - 10 h), supply voltage: 24-48 V DC/24-240 V AC, 1 changeover contact

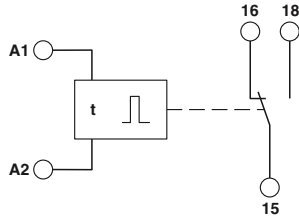

U = 24 ... 48 V DC / 24 ... 240 V AC

Technical data	
Input voltage	24 V DC ... 48 V DC -10 % ... +10 % 24 V AC ... 240 V AC -15 % ... +10 %
Setting range	50 ms ... 10 h (6 time end ranges)
Ambient temperature (operation)	-25 °C ... 50 °C
Ambient temperature (storage/transport)	-40 °C ... 70 °C
Connection method	Screw connection
Connection cross section (solid / stranded / AWG)	0.25 - 2.5 mm <sup>2</sup> / 0.25 - 2.5 mm <sup>2</sup> / 23 - 14

Type	Item No.	Pcs./Pkt.
TR-ES-ON-24/240-10H	2907319	1

### Timer relay

Timer relay with delay release function and an adjustable time range (50 ms - 10 h), supply voltage: 24-48 V DC/24-240 V AC, 1 changeover contact

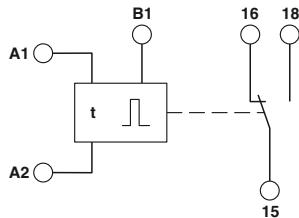

U = 24 ... 48 V DC / 24 ... 240 V AC

Technical data	
Input voltage	24 V DC ... 48 V DC -10 % ... +10 % 24 V AC ... 240 V AC -15 % ... +10 %
Setting range	50 ms ... 10 h (6 time end ranges)
Ambient temperature (operation)	-25 °C ... 50 °C
Ambient temperature (storage/transport)	-40 °C ... 70 °C
Connection method	Screw connection
Connection cross section (solid / stranded / AWG)	0.25 - 2.5 mm <sup>2</sup> / 0.25 - 2.5 mm <sup>2</sup> / 23 - 14

Type	Item No.	Pcs./Pkt.
TR-ES-OFF-CC-24/240-10H	2907320	1

### Timer relay

Multi-functional timer relay with 7 functions and an adjustable time range (50 ms - 10 h), supply voltage: 24 V DC ... 48 V DC/24 V DC ... 240 V AC, 1 changeover contact

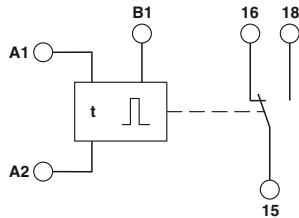

U = 24 ... 48 V DC / 24 ... 240 V AC

Technical data	
Input voltage	24 V DC ... 48 V DC -10 % ... +10 % 24 V AC ... 240 V AC -15 % ... +10 %
Setting range	50 ms ... 10 h (6 time end ranges)
Ambient temperature (operation)	-25 °C ... 50 °C
Ambient temperature (storage/transport)	-40 °C ... 70 °C
Connection method	Screw connection
Connection cross section (solid / stranded / AWG)	0.25 - 2.5 mm <sup>2</sup> / 0.25 - 2.5 mm <sup>2</sup> / 23 - 14

Type	Item No.	Pcs./Pkt.
TR-ES-MUL-24/240-10H	2907322	1



### Voltage monitoring relay

Monitoring relay for monitoring 3-phase voltages of 400 V AC (3N~400/230 V AC)  $\pm 30\%$ , undervoltage, window, phase sequence, phase failure, 1 changeover contact, with screw connection



Technical data	
Certification	CE
Functions	Undervoltage, phase sequence, phase failure
Input ranges	400 V (3N ~ 400/230 V)
Setting range Min. (from input signal)	70 % ... 120 % (From $U_N$ )
Setting range Max. (from input signal)	80 % ... 130 % (From $U_N$ )
Setting range for response delay	0.1 s ... 10 s
Setting accuracy	$\pm 5\%$ (of scale end value)
Contact type	1 floating changeover contact
Supply voltage	$\pm 30\%$ (= measuring voltage)
Recovery time	500 ms
Ambient temperature (operation)	-25 °C ... 55 °C

Type	Item No.	Pcs./Pkt.
MR-ES-3V-400	1217805	1

### Phase monitoring relay

Monitoring relay for monitoring the phase sequence, phase failure and asymmetry of 3-phase voltages at 400 V AC (3N~400/230 V AC)  $\pm 30\%$ , configurable asymmetry, 1 changeover contact, with screw connection



Technical data	
Certification	CE
Functions	Phase sequence, phase failure, asymmetry
Input ranges	400 V (3N ~ 400/230 V)
Setting range for response delay	100 ms
Setting accuracy	$\leq 5\%$ (of scale end value)
Contact type	1 floating changeover contact
Supply voltage	$\pm 30\%$ (= measuring voltage)
Recovery time	500 ms
Ambient temperature (operation)	-25 °C ... 55 °C

Type	Item No.	Pcs./Pkt.
MR-ES-PH-400	1217806	1

# Safety relays



## Safety relays

You can use our safety relays to realize reliable safety functions in machines and systems. You can monitor signals from emergency switching off buttons, light grids, and safety door switches, and initiate a safe state when necessary. The ESSENTIAL edition product range includes safety relays for machine building and safe coupling relays for the process industry.

## Product range overview

Safety relays for machine building	<b>86</b>
Safe coupling relays for the process industry	<b>87</b>

**Certified safety technology**

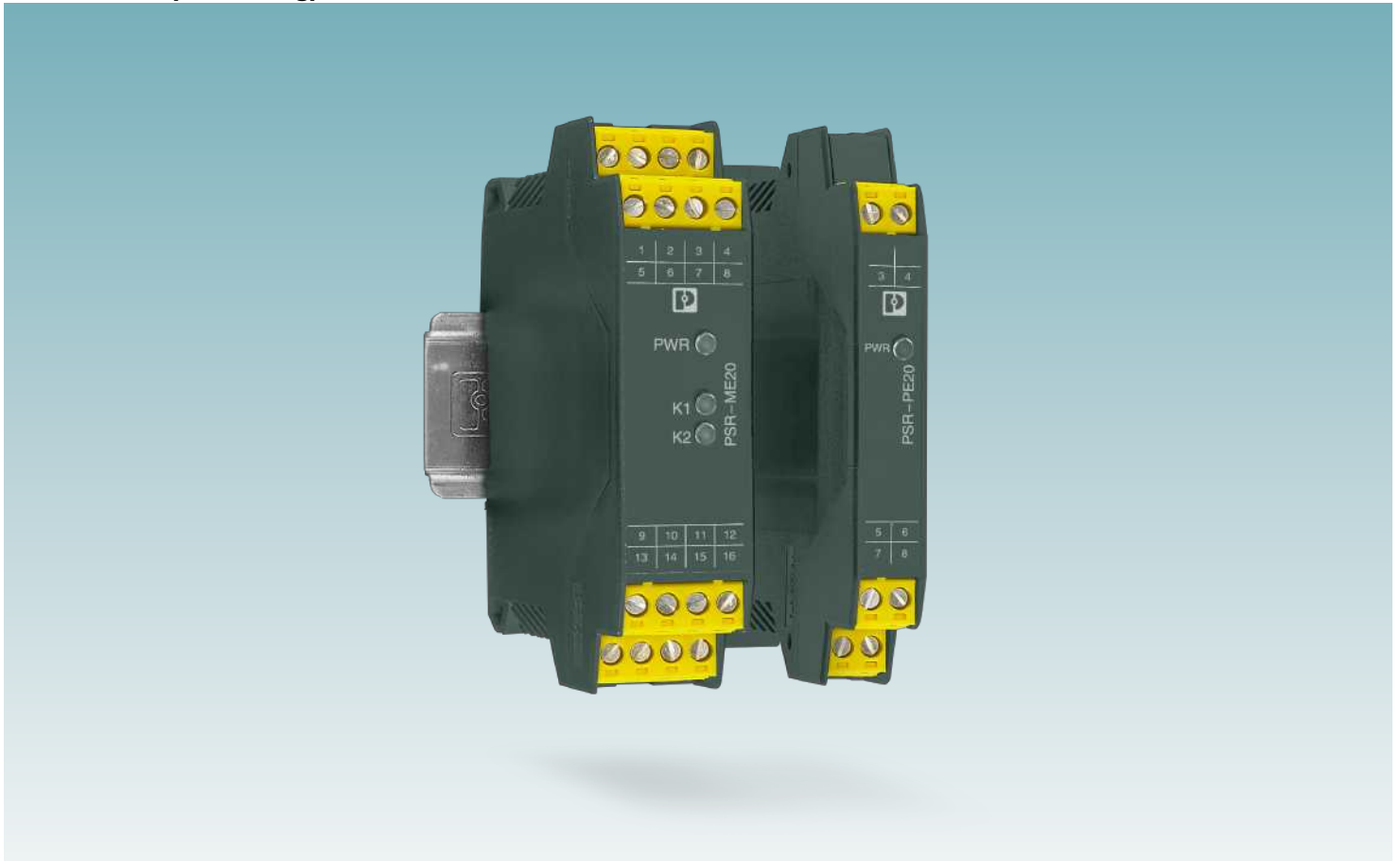

You can protect your machines and systems reliably with our ESSENTIAL edition safety relays. The ESSENTIAL edition safety relays cover all safety-related basic functions for use in machine building and in the process industry.

The PSR-ME20 safety relay is suitable for monitoring various safety functions, such as emergency switching off functions, light grids, and safety doors. Use our safe PSR-PE20 coupling relay for emergency-shutdown applications as well as for electrical isolation and power adjustment in the processing environment.

All ESSENTIAL edition safety relays are TÜV-certified and safeguard your machines and systems in accordance with applicable safety regulations up to SIL 2/SIL 3.

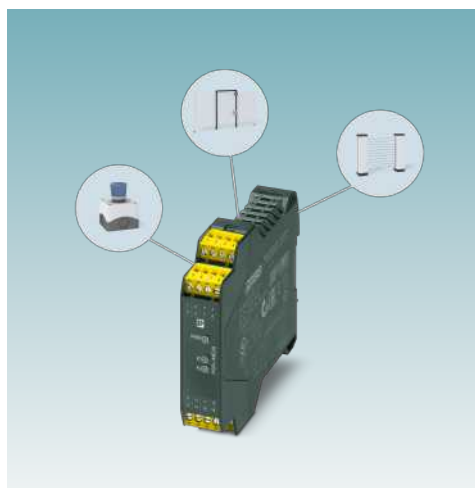

**Several functions in just one device**

Our PSR-ME20 safety relay for machine building is multifunctional in use. The device can reliably monitor signals from emergency switching off buttons, light grids, and safety door switches, and can initiate a safe state when necessary. The safety relay is ideally suited for flexible applications with just a few safety functions.



**For universal use**

The ESSENTIAL edition safety relays are TÜV-certified and have all necessary international approvals for use anywhere in the world.

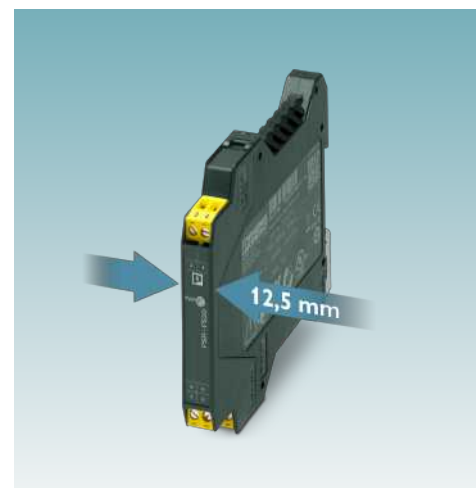

**Space saving with a compact design**

Our PSR-PE20 safety coupling relay, with a very narrow housing width of just 12.5 mm, is particularly space-saving. The device is suitable for low-demand applications in the processing environment. It has an internal 1oo3 structure and can realize emergency shutdowns up to SIL 3.

**Your advantages:**

- ✓ Approvals for all global markets
- ✓ Safe use in machine building up to PL d in accordance with EN ISO 13849-1 and SIL 2 in accordance with IEC 62061
- ✓ Safe use in the processing environment up to SIL 3 in accordance with IEC 61508, IEC 61511, and IEC 50156

# Safety relays

## Safety relays for machine building

### Safety relays

Safety relay for emergency stops, safety doors, and light grids up to SIL 2, Cat. 3, PL d, 1- or 2-channel operation, automatic or manual, monitored start, 3 enabling current paths, 1 signaling current path,  $U_S = 24\text{ V DC}$ , plug-in screw terminal block

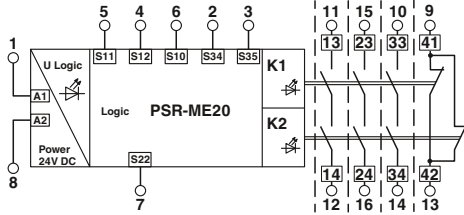

Technical data	
Dimensions W/H/D	22.5 mm / 112.2 mm / 114.5 mm
Ambient temperature (operation)	-20 °C ... 55 °C (observe derating)
Rated control circuit supply voltage $U_S$	24 V DC -15 % / +10 %
Rated control supply current $I_S$	typ. 70 mA (at $U_S$ )
Contact type	3 enabling current paths
Connection method	Screw connection
pluggable	yes
Performance level	d
Safety Integrity Level (SIL)	2

Type	Item No.	Pcs./Pkt.
PSR-ME20-3NO-1NC-24DC-SC	1301402	1

### Safety relays

Set comprised of 35 safety relays for emergency stops, safety doors, and light grids up to SIL 2, Cat. 3, PL d, 1- or 2-channel operation, automatic or manual, monitored start, 3 enabling current paths, 1 signaling current path,  $U_S = 24\text{ V DC}$ , plug-in screw terminal block

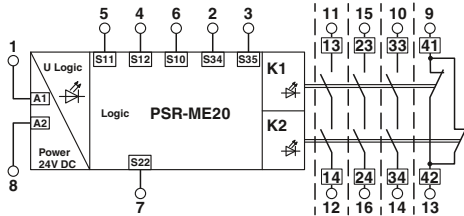

Technical data	
Dimensions W/H/D	22.5 mm / 112.2 mm / 114.5 mm
Ambient temperature (operation)	-20 °C ... 55 °C (observe derating)
Rated control circuit supply voltage $U_S$	24 V DC -15 % / +10 %
Rated control supply current $I_S$	typ. 70 mA (at $U_S$ )
Contact type	3 enabling current paths
Connection method	Screw connection
pluggable	yes
Performance level	d
Safety Integrity Level (SIL)	2

Type	Item No.	Pcs./Pkt.
PSR-ME20-3NO-1NC-24DC-SC-SET35	1301404	1

### Coupling relay

Coupling relay for SIL 3 low-demand applications, couples digital output signals to the I/O, 1 independently controllable enabling current path, safe state off applications, test pulse filter, plug-in screw terminal block

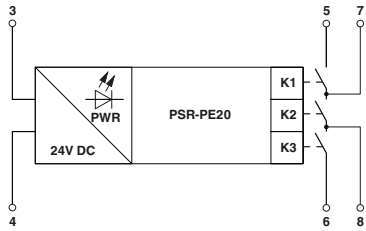

Technical data	
Dimensions W/H/D	12.5 mm / 99 mm / 114.5 mm
Ambient temperature (operation)	-40 °C ... 70 °C (observe derating)
Rated control circuit supply voltage $U_S$	24 V DC -10 % ... +10 %
Rated control supply current $I_S$	40 mA
Switching voltage	min. 12 V DC / max. 250 V AC/DC (Observe the load curve)
Limiting continuous current	4 A (Low demand)
Connection method	Screw connection
Safety Integrity Level (SIL)	3

Type	Item No.	Pcs./Pkt.
PSR-PE20-1NO-24DC-SC	1119573	1

### Coupling relay

Set of 60 coupling relays for SIL 3 low-demand applications, couples digital output signals to the I/O, 1 independently controllable enabling current path, safe state off applications, test pulse filter, plug-in screw terminal block

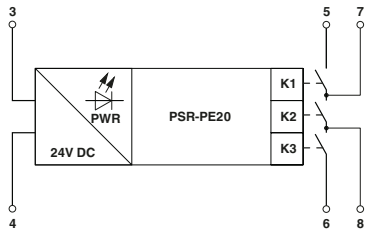

Technical data	
Dimensions W/H/D	12.5 mm / 99 mm / 114.5 mm
Ambient temperature (operation)	-40 °C ... 70 °C (observe derating)
Rated control circuit supply voltage $U_S$	24 V DC -10 % ... +10 %
Rated control supply current $I_S$	40 mA
Switching voltage	min. 12 V DC / max. 250 V AC/DC (Observe the load curve)
Limiting continuous current	4 A (Low demand)
Connection method	Screw connection
Safety Integrity Level (SIL)	3

Type	Item No.	Pcs./Pkt.
PSR-PE20-1NO-24DC-SC-SET60	1272930	1



# Energy monitoring



### **Energy monitoring**

The ESSENTIAL edition energy meters with MID approval in accordance with EN 50470 enable billing based on energy data. The series includes three-phase energy meters and single-phase energy meters that are suitable for industrial and civil applications.

## **Product range overview**

---

MID energy meters

**92**

---

**MID energy meters**



The ESSENTIAL edition energy meters with MID approval in accordance with EN 50470 enable billing based on energy data. The series includes three-phase energy meters and single-phase energy meters that are suitable for industrial and civil applications.

Both product types offer the following features:

- a measurement input for active and reactive power with accuracy class B
- two pulse outputs
- RS-485 communication via Modbus/RTU
- an extended operating range from -40°C to +70°C

The backlit LCD displays the key electrical parameters. These parameters can be easily queried via the buttons on the front.



### Save time and money

The versions with direct current measurement save you wiring effort and the cost of an external current transformer.



### Integrated web server

The Ethernet-based measuring devices enable you to perform remote configuration, access data remotely, and save energy data via the web server.



### Database for your energy audit

Energy measurement technology provides the basis for your energy audit. EMpro energy meters with MID approval comply with statutory weights and measures regulations.

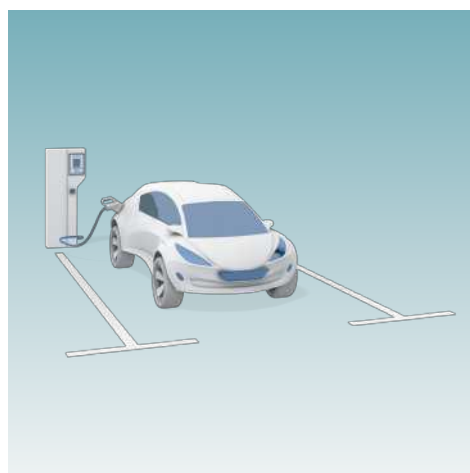

### Energy data acquisition in e-mobility

Energy meters with Modbus/RTU interface and direct measurement up to 80 A are particularly suitable for billing-related energy data acquisition.

#### Your advantages:

- ✓ Save time and money: Three-phase version with direct current measurement up to 100 A and 45 A for the single-phase version
- ✓ Suitable for several wiring systems: The three-phase energy meter can be used in 3P4W, 3P3W, and 1P2W systems
- ✓ Remote access, storage, and export of data with Modbus/RTU
- ✓ Extended temperature range up to 70°C
- ✓ Satisfies MID certification standards

# Energy monitoring

## MID energy meters

### Energy meter

This device is a digital single-phase electric energy measuring device, suitable for measuring active power in the 230 V / 45 A power grid by the method of direct measurement, with 2 pulse outputs, RS-485 interface, and operating temperature up to +70°C, certified in accordance with the MID directive.



Technical data	
Input voltage range	176 V AC ... 276 V
Power consumption	10 VA (2 W)
Frequency range	50 Hz
Energy (EN 50470-3)	Class B
Real energy (IEC 62053-21)	Class 1
Reactive power (IEC 62053-23)	Class 2
Output signal	Pulse input
Output description	Passive opto-isolated
Communication protocol	Modbus
Ambient temperature (operation)	-40 °C ... 70 °C

Type	Item No.	Pcs./Pkt.
EEM-EM157-EE	1311993	10

### Energy meter

This device is a digital three-phase electric energy measuring device, suitable for measuring active power by direct measurement in the power grid not exceeding 480 V / 100 A, with 2 pulse outputs, RS-485 interface, and operating temperature up to +70°C, certified in accordance with the MID directive.



Technical data	
Input voltage range	3x 184 V ... 276 V (320 V ... 480 V)
Power consumption	10 VA (2 W)
Frequency range	50 Hz
Energy (EN 50470-3)	Class B
Real energy (IEC 62053-21)	Class 1
Reactive power (IEC 62053-23)	Class 2
Output signal	Pulse input
Output description	Passive opto-isolated
Ambient temperature (operation)	40 °C ... 70 °C

Type	Item No.	Pcs./Pkt.
EEM-EM357-EE	1311985	1



# Signal conditioner

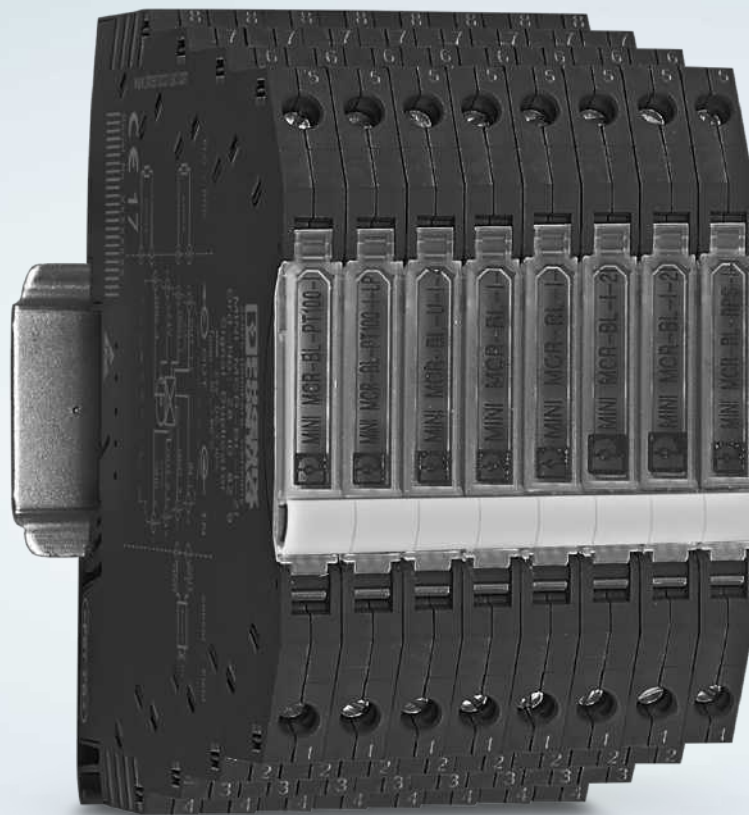



## Signal conditioner

The highly compact signal conditioners feature electrical isolation, signal conversion, signal filtering, and signal amplification for comprehensive signal conditioning.

## Product range overview

---

Signal conditioners with basic functionality

**98**

---

## Signal conditioner

### Quality features

---

#### Particularly space-saving

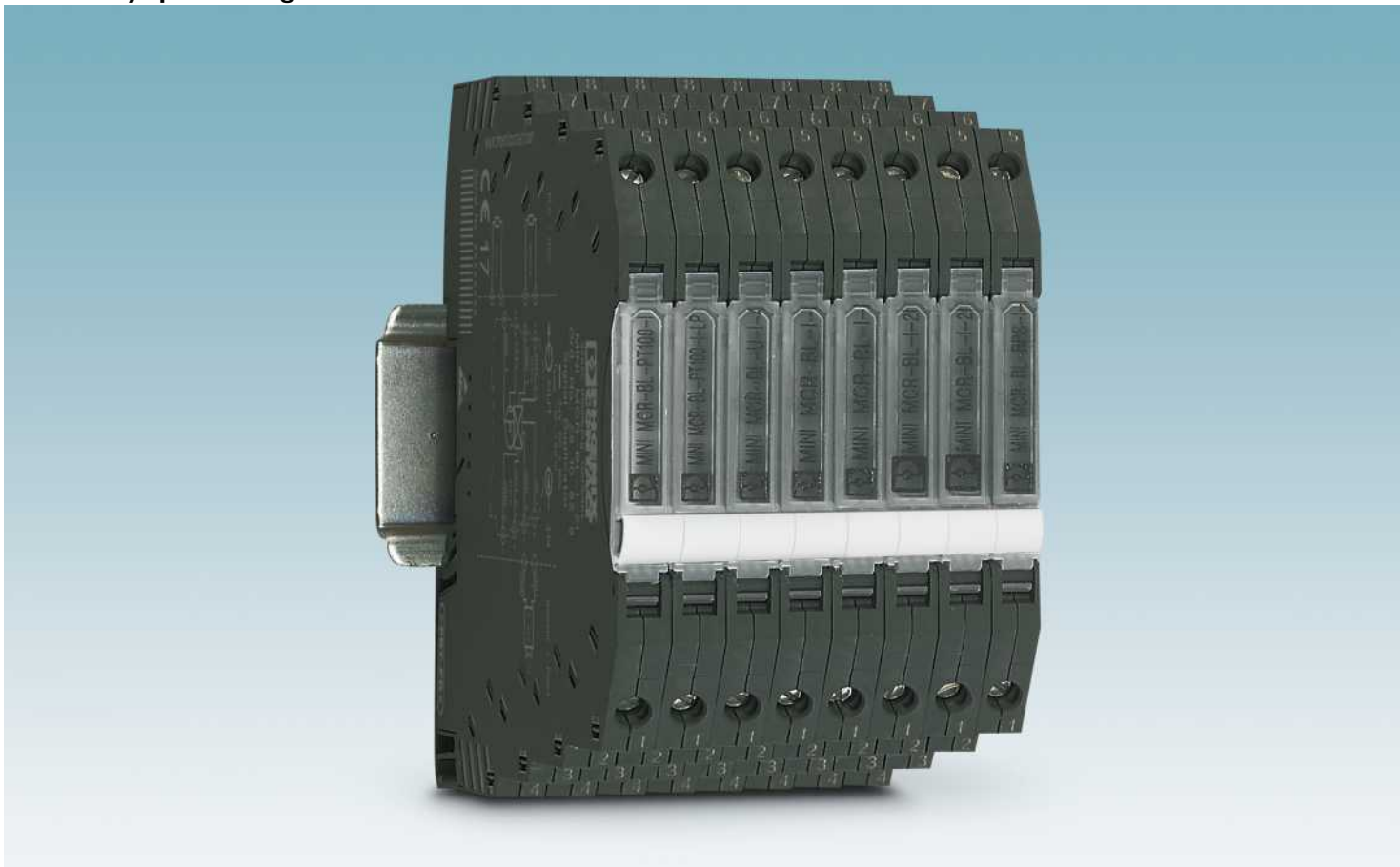

Record temperatures and isolate, convert, filter, and amplify signals with an overall width of just 6.2 mm. In terms of application, the ESSENTIAL edition signal conditioners are space-saving and efficient with proven quality.



### Space-saving

With the narrow analog modules, you can save up to 65 percent more space compared to other signal conditioners on the market with overall widths of 12.5 mm to 22.5 mm.



### High operational reliability

The continuous electrical isolation between input, output, and supply increases the operational safety in the event of disturbances in your system.



### Easy configuration

Many of the analog modules can be configured: Settings can be made via the easily accessible DIP switches – without the need for any software.

### Your advantages:

- ✓ Save up to 65 percent space compared to other signal conditioners on the market, thanks to the 6.2 mm overall width
- ✓ High operational safety in the event of disturbances, thanks to 3-way electrical isolation
- ✓ Convenient configuration via DIP switch

# Signal conditioner

## Signal conditioners with basic functionality

### MINI Analog, Signal conditioner, Input signal Current, Output signal Current

MCR 3-way isolating amplifier, for electrical isolation of analog signals, with screw connection, input signal: 0(4) mA ... 20 mA, output signal: 0(4) mA ... 20 mA

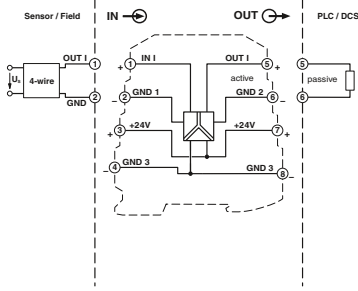

Technical data	
Input signal	0 mA ... 20 mA / 4 mA ... 20 mA
Input resistance U / I	approx. 50 Ω
Output signal	0 mA ... 20 mA / 4 mA ... 20 mA
Load U / I	< 500 Ω (at 20 mA)
Supply voltage	19.2 V DC ... 30 V DC
Transmission error	< 0.1 % (of final value)
Temperature coefficient	< 0.01 %/K
Ambient temperature (operation)	-10 °C ... 60 °C
Connection method	Screw connection
Connection cross section (solid / stranded / AWG)	0.2 - 2.5 mm <sup>2</sup> / 0.2 - 2.5 mm <sup>2</sup> / 26 - 12

Type	Item No.	Pcs./Pkt.
MINI MCR-BL-I-I	2810463	1

### MINI Analog, Signal conditioner, Input signal Voltage, Output signal Current

MCR 3-way isolating amplifier, for electrical isolation of analog signals, with screw connection, input signal: 0 V ... 10 V, output signal: 4 mA ... 20 mA

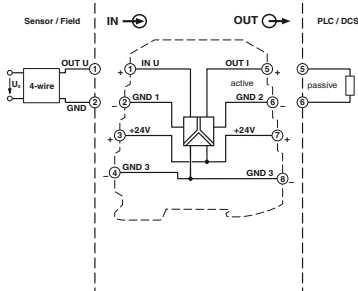

Technical data	
Input signal	0 V ... 10 V
Input resistance U / I	approx. 100 kΩ
Output signal	4 mA ... 20 mA
Load U / I	≤ 500 Ω
Supply voltage	19.2 V DC ... 30 V DC
Transmission error	< 0.1 % (of final value)
Temperature coefficient	< 0.01 %/K
Ambient temperature (operation)	-10 °C ... 60 °C
Connection method	Screw connection
Connection cross section (solid / stranded / AWG)	0.2 - 2.5 mm <sup>2</sup> / 0.2 - 2.5 mm <sup>2</sup> / 26 - 12

Type	Item No.	Pcs./Pkt.
MINI MCR-BL-U-I-4	2810492	1

### MINI Analog, Signal conditioner, Input signal Current, Output signal Voltage

3-way isolating amplifier for the electrical isolation of analog signals, I/O can be configured via DIP switches, with screw connection, standard configuration

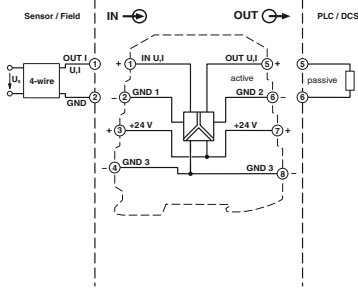

Technical data	
Input signal	0 V ... 5 V / 1 V ... 5 V / 0 V ... 10 V / 2 V ... 10 V / 0 mA ... 20 mA / 4 mA ... 20 mA
Input resistance U / I	approx. 100 kΩ / approx. 50 Ω
Output signal	0 V ... 5 V / 1 V ... 5 V / 0 V ... 10 V / 2 V ... 10 V / 0 mA ... 20 mA / 4 mA ... 20 mA
Load U / I	≥ 10 kΩ / < 500 Ω (at 20 mA)
Supply voltage	19.2 V DC ... 30 V DC
Transmission error	< 0.2 % (of final value)
Ambient temperature (operation)	-10 °C ... 60 °C
Connection method	Screw connection
Connection cross section (solid / stranded / AWG)	0.2 - 2.5 mm <sup>2</sup> / 0.2 - 2.5 mm <sup>2</sup> / 26 - 12

Type	Item No.	Pcs./Pkt.
MINI MCR-BL-UI-I	1070346	1

### MINI Analog, Signal duplicator, Input signal Current, Output signal Current

MCR 4-way signal duplicator for electrical isolation and duplication of analog signals with screw connection, input signal: 4 mA ... 20 mA, output signal: 2 x 4 mA ... 20 mA

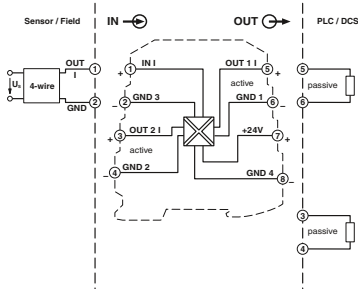

Technical data	
Input signal	4 mA ... 20 mA
Input resistance U / I	approx. 50 Ω
Output signal	2x 4 mA ... 20 mA
Load U / I	≤ 250 Ω (at 20 mA)
Supply voltage	19.2 V DC ... 30 V DC
Transmission error	≤ 0.2 % (of final value)
Temperature coefficient	< 0.01 %/K
Ambient temperature (operation)	-10 °C ... 60 °C
Connection method	Screw connection
Connection cross section (solid / stranded / AWG)	0.2 - 2.5 mm <sup>2</sup> / 0.2 - 2.5 mm <sup>2</sup> / 26 - 12

Type	Item No.	Pcs./Pkt.
MINI MCR-BL-I-2I	2810829	1

### MINI Analog, Repeater power supplies, Input signal Current, Output signal Current

MCR repeater power supplies, screw connection, input signal: (0)4...20 mA, output signal: (0)4...20 mA

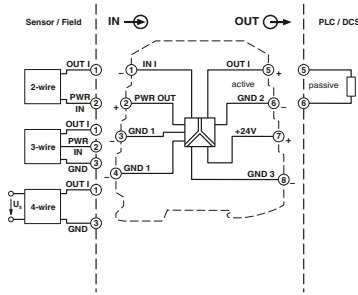

Technical data	
Input signal	0 mA ... 20 mA / 4 mA ... 20 mA
Input resistance U / I	approx. 50 Ω
Output signal	0 mA ... 20 mA / 4 mA ... 20 mA
Load U / I	≤ 500 Ω (I = 20 mA)
Supply voltage	19.2 V DC ... 30 V DC
Transmission error	≤ 0.2 % (of final value)
Temperature coefficient	< 0.01 %/K
Ambient temperature (operation)	-10 °C ... 60 °C
Connection method	Screw connection
Connection cross section (solid / stranded / AWG)	0.2 - 2.5 mm <sup>2</sup> / 0.2 - 2.5 mm <sup>2</sup> / 26 - 12

Type	Item No.	Pcs./Pkt.
MINI MCR-BL-RPS-I	2810476	1

### MINI Analog, Temperature transmitter

MCR temperature transducer, configurable, for Pt 100 temperature sensors for the measuring range -50°C ... 200 °C, screw connection

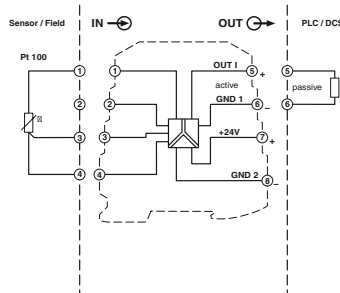

Technical data	
Temperature range	-50 °C ... 200 °C
Temperature measuring range	min. 50 K
Sensor types that can be used	Pt 100 (IEC 60751/EN 60751)
Output signal	0 mA ... 20 mA / 4 mA ... 20 mA
Load U / I	< 500 Ω (at 20 mA)
Supply voltage	19.2 V DC ... 30 V DC
Temperature coefficient	< 0.02 %/K
Ambient temperature (operation)	-10 °C ... 60 °C
Connection method	Screw connection
Connection cross section (solid / stranded / AWG)	0.2 - 2.5 mm <sup>2</sup> / 0.2 - 2.5 mm <sup>2</sup> / 26 - 12

Type	Item No.	Pcs./Pkt.
MINI MCR-BL-PT100-I-NC	2810489	1

### MINI Analog, Temperature transmitter

Loop-powered MCR temperature transducer, configurable, for Pt 100 temperature sensors for the measuring range -150°C ... 300 °C, screw connection

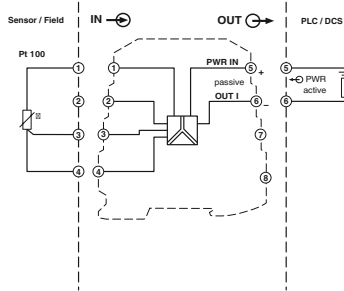

Technical data	
Temperature range	-150 °C ... 300 °C
Temperature measuring range	min. 50 K
Sensor types that can be used	Pt 100 (IEC 60751/EN 60751)
Output signal	4 mA ... 20 mA
Load U / I	(U <sub>supply</sub> - 12 V) / 22 mA
Supply voltage	12 V DC ... 30 V DC
Temperature coefficient	< 0.02 %/K
Ambient temperature (operation)	-10 °C ... 60 °C
Connection method	Screw connection
Connection cross section (solid / stranded / AWG)	0.2 - 2.5 mm <sup>2</sup> / 0.2 - 2.5 mm <sup>2</sup> / 26 - 12

Type	Item No.	Pcs./Pkt.
MINI MCR-BL-PT100-I-LP-NC	2810609	1

# Industrial communication



## Industrial communication

Industrial communication modules feature precision connection functions for the use of serial cables. Whether the application requires wireless data transmission over distances of 5 km or a global Ethernet connection, the ESSENTIAL edition communication modules feature the right components for you.

## Product range overview

Wireless modules with basic functionality	<b>104</b>
Protocol converters with basic functionality	<b>105</b>



### Wireless modules for serial cable replacement



Industrial communication modules feature precision connectivity functions for the use of serial cables. Whether the application requires wireless data transmission over distances of 5 km or global Ethernet connectivity, the ESSENTIAL edition communication modules feature the right components for you.

The ESSENTIAL edition wireless modules with essential functions reliably transmit your serial data. They ensure a higher availability than comparable wireless technologies thanks to a high number of narrow-band wireless channels, along with an automatic and manual coexistence mechanism. Convenient and clear software assistants ensure quick and easy installation. Moreover, their international approvals package allows you to use them anywhere in the world. The ESSENTIAL edition wireless module is ideal for use in environments with electromagnetic interference because the wireless communication in the 2.4 GHz band is immune to external EMI, and is therefore perfect for use in photovoltaic systems.

The ESSENTIAL edition device server features flexible options for transmitting serial data via Ethernet. With the switchboard component housing and the standard operating environments, this device server is perfectly suited for commercial and IT applications. Numerous serial interface profiles simplify the configuration process for the Modbus gateway functionality. This enables seamless communication between Modbus/ASCII, Modbus/RTU, and Modbus/TCP devices.



With Trusted Wireless modules, you obtain reliable, interference-free communication, particularly in environments with electromagnetic disturbance.



Commission the wireless connection intuitively. The convenient Software Wizard will assist you.



You can use the wireless modules everywhere in your applications. Thanks to the license-free 2.4 GHz frequency band and an international approval package, the devices can be used worldwide.



Numerous serial interface profiles simplify the configuration process for the Modbus gateway functionality. The profiles support the simultaneous connection with several hosts, including up to 1,024 incoming bases and up to 49 outgoing bases.

#### Your advantages:

- ✓ For worldwide use, thanks to the license-free 2.4 GHz ISM band
- ✓ Intuitive commissioning of the wireless connection using the convenient Software Wizard
- ✓ Reliable, interference-free communication even over long distances, thanks to Trusted Wireless technology
- ✓ Simplified configuration with individual profiles
- ✓ Simultaneous connection to several hosts

# Industrial communication

## Wireless modules with basic functionality

### Wireless module

2.4 GHz wireless transceiver with RS-485 interface, RSMA (female) antenna connection, point-to-point, star, and mesh networks up to 250 stations, range of up to 500 m (with a clear line of sight), for worldwide use



You can request the free configuration and diagnostics software via the Internet at [phoenixcontact.net/products](http://phoenixcontact.net/products). To do this, select the Download item on the article's product page.

#### Technical data

Description	2.4 GHz wireless transceiver, for worldwide use
Wireless standard	Trusted Wireless
Wireless licenses	Europe, USA, Canada, additional countries in the e-shop
Dimensions W/H/D	17.5 mm / 116 mm / 114.5 mm

	Type	Item No.	Pcs./Pkt.
	RAD-EE-2400-RS485	1081818	1

Accessories	Type	Item No.	Pcs./Pkt.
Cable for programming	RAD-CABLE-USB	2903447	1
Omnidirectional antenna, Gain 2 dBi (689 ... 2700 MHz), Cable length 1.50 m	ANT-OMNI-0627-01	1089617	1
Shield connection clamp, 3 - 8 mm <sup>2</sup> , mounting type: NS 35/7,5	SKS 8-SNS35	3062786	10

**Interface converter**

Serial device server for converting serial data (RS-232/422/485) to Ethernet data (RJ45). Supports TCP and UDP protocols in addition to Modbus RTU (or ASCII) and Modbus TCP. COM port redirector software is available for download. Includes one RJ45 port and one D-SUB 9 port.



Technical data	
Supply voltage	9 V DC ... 30 V DC (via barrel connector, 610 mm pigtail included)
Copper interface	Ethernet interface, 10/100Base-T(X) in accordance with IEEE 802.3
Connection method	RJ45 jack, shielded
Transmission speed	10/100 Mbps, auto negotiation
Transmission length	≤ 100 m (shielded twisted pair)
Ambient temperature (operation)	0 °C ... 55 °C
Dimensions W/H/D	87 mm / 94.8 mm / 23.2 mm

Type	Item No.	Pcs./Pkt.
GW DS1	1182119	1

# Sensor/actuator cabling



### Sensor/actuator cabling

With a wide range of Phoenix Contact products and solutions for the cabling of sensors and actuators, it can be ensured that the system operates with safety and stability.

## Product range overview

---

Sensor/actuator cable	<b>110</b>
-----------------------	------------

---

## Sensor/actuator cabling

### Quality features

---

#### Reliable in the field



Save time and money – with plug-in sensor/actuator cabling instead of traditional single wiring. Connect your sensors and actuators quickly and safely in the field. We provide consistent product ranges for passive field cabling with convenient and reliable connection technologies. From product development to series production – the high quality of Phoenix Contact products is assured through consistent testing in accordance with uniform directives and in-house standards.



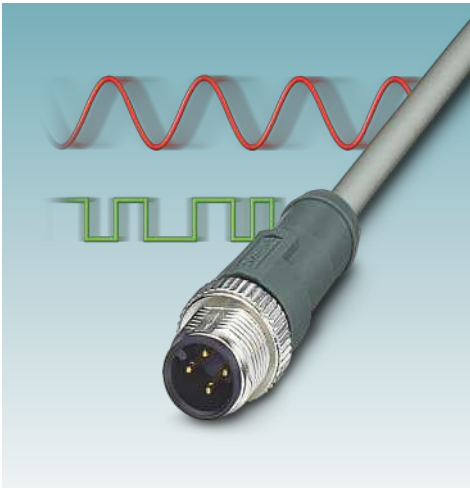

**100 % tested**

All supplied components are 100% electrically checked by Quality Assurance.



**For increased loads**

Our PUR cable is well suited for areas with increased stresses, such as for metal machining. It is resistant to chemicals, oil and lubricants. The low-cost PVC cables can be used in areas with average mechanical strain, such as in packaging systems or assembly machines

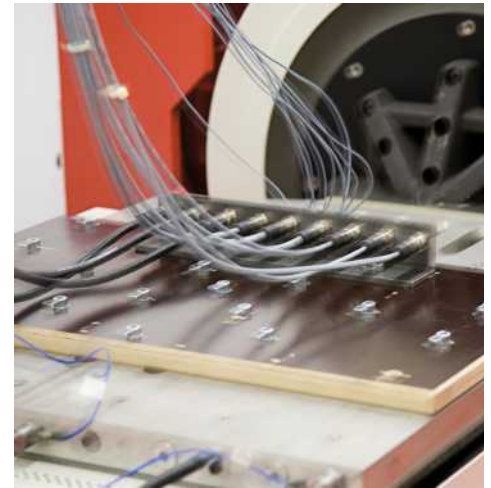

**Securely locked**

An integrated vibration brake prevents the unintentional loosening of the plug-in connection in the event of vibrations and ensures a secure, permanent connection.

# Sensor/actuator cabling

## Sensor/actuator cable

### Sensor/actuator cable, 3-position, PUR



Common technical data	
Rated voltage	250 V AC / 250 V DC
Rated current	4 A
Contact material	CuSn
Contact surface material	Ni/Au
Material of grip body	TPU, hardly inflammable, self-extinguishing
Status indication	No
Degree of protection	IP65
Temperature data	-25 °C ... 90 °C
Plug/socket	

Cable length	Type	Item No.	Pcs./Pkt.
2 m	SAC-3P-M12MS/2,0-E10	1411706	1
5 m	SAC-3P-M12MS/5,0-E10	1411707	1
10 m	SAC-3P-M12MS/10,0-E10	1411708	1
2 m	SAC-3P-M12MR/2,0-E10	1411709	1
5 m	SAC-3P-M12MR/5,0-E10	1411710	1
10 m	SAC-3P-M12MR/10,0-E10	1411711	1

### Sensor/actuator cable, 3-position, PUR



Common technical data	
Rated voltage	250 V AC / 250 V DC
Rated current	4 A
Contact material	CuSn
Contact surface material	Ni/Au
Material of grip body	TPU, hardly inflammable, self-extinguishing
Status indication	No
Degree of protection	IP65
Temperature data	-25 °C ... 90 °C
Plug/socket	

Cable length	Type	Item No.	Pcs./Pkt.
2 m	SAC-3P-2,0-E10/M12FS	1411712	1
5 m	SAC-3P-5,0-E10/M12FS	1411713	1
10 m	SAC-3P-10,0-E10/M12FS	1411714	1
2 m	SAC-3P-2,0-E10/M12FR	1411715	1
5 m	SAC-3P-5,0-E10/M12FR	1411717	1
10 m	SAC-3P-10,0-E10/M12FR	1411718	1

### Sensor/actuator cable, 3-position, PUR



Common technical data	
Rated voltage	250 V AC / 250 V DC
Rated current	4 A
Contact material	CuSn
Contact surface material	Ni/Au
Material of grip body	TPU, hardly inflammable, self-extinguishing
Status indication	No
Degree of protection	IP65
Temperature data	-25 °C ... 90 °C
Plug/socket	

Cable length	Type	Item No.	Pcs./Pkt.
0.6 m	SAC-3P-M12MR/0,6-E10/M12FR	1411719	1
1 m	SAC-3P-M12MR/1,0-E10/M12FR	1411720	1
2 m	SAC-3P-M12MR/2,0-E10/M12FR	1411721	1
5 m	SAC-3P-M12MR/5,0-E10/M12FR	1411722	1
0.6 m	SAC-3P-M12MS/0,6-E10/M12FS	1411724	1
1 m	SAC-3P-M12MS/1,0-E10/M12FS	1411725	1
2 m	SAC-3P-M12MS/2,0-E10/M12FS	1411726	1
5 m	SAC-3P-M12MS/5,0-E10/M12FS	1411727	1

Sensor/actuator cable, 3-position, PVC



Common technical data	
Rated voltage	250 V AC / 250 V DC
Rated current	4 A
Contact material	CuSn
Contact surface material	Ni/Au
Material of grip body	TPU, hardly inflammable, self-extinguishing
Status indication	No
Degree of protection	IP65
Temperature data	-25 °C ... 90 °C
Plug/socket	

Cable length	Type	Item No.	Pcs./Pkt.
2 m	SAC-3P-M12MS/2,0-E20	1410862	1
5 m	SAC-3P-M12MS/5,0-E20	1410863	1
10 m	SAC-3P-M12MS/10,0-E20	1410864	1
2 m	SAC-3P-M12MR/2,0-E20	1410865	1
5 m	SAC-3P-M12MR/5,0-E20	1410866	1
10 m	SAC-3P-M12MR/10,0-E20	1410867	1

Sensor/actuator cable, 3-position, PVC



Common technical data	
Rated voltage	250 V AC / 250 V DC
Rated current	4 A
Contact material	CuSn
Contact surface material	Ni/Au
Material of grip body	TPU, hardly inflammable, self-extinguishing
Status indication	No
Degree of protection	IP65
Temperature data	-25 °C ... 90 °C
Plug/socket	

Cable length	Type	Item No.	Pcs./Pkt.
2 m	SAC-3P-2,0-E20/M12FS	1410868	1
5 m	SAC-3P-5,0-E20/M12FS	1410869	1
10 m	SAC-3P-10,0-E20/M12FS	1410871	1
2 m	SAC-3P-2,0-E20/M12FR	1410872	1
5 m	SAC-3P-5,0-E20/M12FR	1410873	1
10 m	SAC-3P-10,0-E20/M12FR	1410874	1

Sensor/actuator cable, 3-position, PVC



Common technical data	
Rated voltage	250 V AC / 250 V DC
Rated current	4 A
Contact material	CuSn
Contact surface material	Ni/Au
Material of grip body	TPU, hardly inflammable, self-extinguishing
Status indication	No
Degree of protection	IP65
Temperature data	-25 °C ... 90 °C
Plug/socket	

Cable length	Type	Item No.	Pcs./Pkt.
0,6 m	SAC-3P-M12MR/0,6-E20/M12FR	1410875	1
1 m	SAC-3P-M12MR/1,0-E20/M12FR	1410876	1
2 m	SAC-3P-M12MR/2,0-E20/M12FR	1410877	1
5 m	SAC-3P-M12MR/5,0-E20/M12FR	1410878	1
0,6 m	SAC-3P-M12MS/0,6-E20/M12FS	1410879	1
1 m	SAC-3P-M12MS/1,0-E20/M12FS	1410880	1
2 m	SAC-3P-M12MS/2,0-E20/M12FS	1410881	1
5 m	SAC-3P-M12MS/5,0-E20/M12FS	1410882	1

# Sensor/actuator cabling

## Sensor/actuator cable

### Sensor/actuator cable, 4-position, PUR



Common technical data	
Rated voltage	250 V AC / 250 V DC
Rated current	4 A
Contact material	CuSn
Contact surface material	Ni/Au
Material of grip body	TPU, hardly inflammable, self-extinguishing
Status indication	No
Degree of protection	IP65
Temperature data	-25 °C ... 90 °C
Plug/socket	

Cable length	Type	Item No.	Pcs./Pkt.
2 m	SAC-4P-M12MS/2,0-E10	1411728	1
5 m	SAC-4P-M12MS/5,0-E10	1411729	1
10 m	SAC-4P-M12MS/10,0-E10	1411730	1
2 m	SAC-4P-M12MR/2,0-E10	1411731	1
5 m	SAC-4P-M12MR/5,0-E10	1411732	1
10 m	SAC-4P-M12MR/10,0-E10	1411733	1

### Sensor/actuator cable, 4-position, PUR



Common technical data	
Rated voltage	250 V AC / 250 V DC
Rated current	4 A
Contact material	CuSn
Contact surface material	Ni/Au
Material of grip body	TPU, hardly inflammable, self-extinguishing
Status indication	No
Degree of protection	IP65
Temperature data	-25 °C ... 90 °C
Plug/socket	

Cable length	Type	Item No.	Pcs./Pkt.
2 m	SAC-4P-2,0-E10/M12FS	1411734	1
5 m	SAC-4P-5,0-E10/M12FS	1411735	1
10 m	SAC-4P-10,0-E10/M12FS	1411736	1
2 m	SAC-4P-2,0-E10/M12FR	1411737	1
5 m	SAC-4P-5,0-E10/M12FR	1411738	1
10 m	SAC-4P-10,0-E10/M12FR	1411739	1

### Sensor/actuator cable, 4-position, PUR



Common technical data	
Rated voltage	250 V AC / 250 V DC
Rated current	4 A
Contact material	CuSn
Contact surface material	Ni/Au
Material of grip body	TPU, hardly inflammable, self-extinguishing
Status indication	No
Degree of protection	IP65
Temperature data	-25 °C ... 90 °C
Plug/socket	

Cable length	Type	Item No.	Pcs./Pkt.
0.6 m	SAC-4P-M12MR/0,6-E10/M12FR	1411740	1
1 m	SAC-4P-M12MR/1,0-E10/M12FR	1411741	1
2 m	SAC-4P-M12MR/2,0-E10/M12FR	1411742	1
5 m	SAC-4P-M12MR/5,0-E10/M12FR	1411743	1
0.6 m	SAC-4P-M12MS/0,6-E10/M12FS	1411744	1
1 m	SAC-4P-M12MS/1,0-E10/M12FS	1411745	1
2 m	SAC-4P-M12MS/2,0-E10/M12FS	1411746	1
5 m	SAC-4P-M12MS/5,0-E10/M12FS	1411747	1

Sensor/actuator cable, 4-position, PVC



Common technical data	
Rated voltage	250 V AC / 250 V DC
Rated current	4 A
Contact material	CuSn
Contact surface material	Ni/Au
Material of grip body	TPU, hardly inflammable, self-extinguishing
Status indication	No
Degree of protection	IP65
Temperature data	-25 °C ... 90 °C
Plug/socket	

Cable length	Type	Item No.	Pcs./Pkt.
2 m	SAC-4P-M12MS/2,0-E20	1410883	1
5 m	SAC-4P-M12MS/5,0-E20	1410884	1
10 m	SAC-4P-M12MS/10,0-E20	1410885	1
2 m	SAC-4P-M12MR/2,0-E20	1410886	1
5 m	SAC-4P-M12MR/5,0-E20	1410887	1
10 m	SAC-4P-M12MR/10,0-E20	1410888	1

Sensor/actuator cable, 4-position, PVC



Common technical data	
Rated voltage	250 V AC / 250 V DC
Rated current	4 A
Contact material	CuSn
Contact surface material	Ni/Au
Material of grip body	TPU, hardly inflammable, self-extinguishing
Status indication	No
Degree of protection	IP65
Temperature data	-25 °C ... 90 °C
Plug/socket	

Cable length	Type	Item No.	Pcs./Pkt.
2 m	SAC-4P-2,0-E20/M12FS	1410889	1
5 m	SAC-4P-5,0-E20/M12FS	1410890	1
10 m	SAC-4P-10,0-E20/M12FS	1410891	1
2 m	SAC-4P-2,0-E20/M12FR	1410892	1
5 m	SAC-4P-5,0-E20/M12FR	1410894	1
10 m	SAC-4P-10,0-E20/M12FR	1410895	1

Sensor/actuator cable, 4-position, PVC



Common technical data	
Rated voltage	250 V AC / 250 V DC
Rated current	4 A
Contact material	CuSn
Contact surface material	Ni/Au
Material of grip body	TPU, hardly inflammable, self-extinguishing
Status indication	No
Degree of protection	IP65
Temperature data	-25 °C ... 90 °C
Plug/socket	

Cable length	Type	Item No.	Pcs./Pkt.
0,6 m	SAC-4P-M12MR/0,6-E20/M12FR	1410896	1
1 m	SAC-4P-M12MR/1,0-E20/M12FR	1410897	1
2 m	SAC-4P-M12MR/2,0-E20/M12FR	1410898	1
5 m	SAC-4P-M12MR/5,0-E20/M12FR	1410899	1
0,6 m	SAC-4P-M12MS/0,6-E20/M12FS	1410900	1
1 m	SAC-4P-M12MS/1,0-E20/M12FS	1410901	1
2 m	SAC-4P-M12MS/2,0-E20/M12FS	1410902	1
5 m	SAC-4P-M12MS/5,0-E20/M12FS	1410904	1

# Sensor/actuator cabling

## Sensor/actuator cable

### Sensor/actuator cable, 5-position, PUR



Common technical data	
Rated voltage	48 V AC / 60 V DC
Rated current	4 A
Contact material	CuSn
Contact surface material	Ni/Au
Material of grip body	TPU, hardly inflammable, self-extinguishing
Status indication	No
Degree of protection	IP65
Temperature data	-25 °C ... 90 °C
Plug/socket	

Cable length	Type	Item No.	Pcs./Pkt.
2 m	SAC-5P-M12MS/2,0-E10	1411749	1
5 m	SAC-5P-M12MS/5,0-E10	1411750	1
10 m	SAC-5P-M12MS/10,0-E10	1411751	1
2 m	SAC-5P-M12MR/2,0-E10	1411752	1
5 m	SAC-5P-M12MR/5,0-E10	1411753	1
10 m	SAC-5P-M12MR/10,0-E10	1411754	1

### Sensor/actuator cable, 5-position, PUR



Common technical data	
Rated voltage	48 V AC / 60 V DC
Rated current	4 A
Contact material	CuSn
Contact surface material	Ni/Au
Material of grip body	TPU, hardly inflammable, self-extinguishing
Status indication	No
Degree of protection	IP65
Temperature data	-25 °C ... 90 °C
Plug/socket	

Cable length	Type	Item No.	Pcs./Pkt.
2 m	SAC-5P-2,0-E10/M12FS	1411755	1
5 m	SAC-5P-5,0-E10/M12FS	1411756	1
10 m	SAC-5P-10,0-E10/M12FS	1411757	1
2 m	SAC-5P-2,0-E10/M12FR	1411758	1
5 m	SAC-5P-5,0-E10/M12FR	1411760	1
10 m	SAC-5P-10,0-E10/M12FR	1411761	1

### Sensor/actuator cable, 5-position, PUR



Common technical data	
Rated voltage	48 V AC / 60 V DC
Rated current	4 A
Contact material	CuSn
Contact surface material	Ni/Au
Material of grip body	TPU, hardly inflammable, self-extinguishing
Status indication	No
Degree of protection	IP65
Temperature data	-25 °C ... 90 °C
Plug/socket	

Cable length	Type	Item No.	Pcs./Pkt.
0.6 m	SAC-5P-M12MR/0,6-E10/M12FR	1411762	1
1 m	SAC-5P-M12MR/1,0-E10/M12FR	1411763	1
2 m	SAC-5P-M12MR/2,0-E10/M12FR	1411764	1
5 m	SAC-5P-M12MR/5,0-E10/M12FR	1411765	1
0.6 m	SAC-5P-M12MS/0,6-E10/M12FS	1411766	1
1 m	SAC-5P-M12MS/1,0-E10/M12FS	1411767	1
2 m	SAC-5P-M12MS/2,0-E10/M12FS	1411768	1
5 m	SAC-5P-M12MS/5,0-E10/M12FS	1411769	1

Sensor/actuator cable, 5-position, PVC



Common technical data	
Rated voltage	48 V AC / 60 V DC
Rated current	4 A
Contact material	CuSn
Contact surface material	Ni/Au
Material of grip body	TPU, hardly inflammable, self-extinguishing
Status indication	No
Degree of protection	IP65
Temperature data	-25 °C ... 90 °C
Plug/socket	

Cable length	Type	Item No.	Pcs./Pkt.
2 m	SAC-5P-M12MS/2,0-E20	1410905	1
5 m	SAC-5P-M12MS/5,0-E20	1410906	1
10 m	SAC-5P-M12MS/10,0-E20	1410907	1
2 m	SAC-5P-M12MR/2,0-E20	1410908	1
5 m	SAC-5P-M12MR/5,0-E20	1410909	1
10 m	SAC-5P-M12MR/10,0-E20	1410910	1

Sensor/actuator cable, 5-position, PVC



Common technical data	
Rated voltage	48 V AC / 60 V DC
Rated current	4 A
Contact material	CuSn
Contact surface material	Ni/Au
Material of grip body	TPU, hardly inflammable, self-extinguishing
Status indication	No
Degree of protection	IP65
Temperature data	-25 °C ... 90 °C
Plug/socket	

Cable length	Type	Item No.	Pcs./Pkt.
2 m	SAC-5P-2,0-E20/M12FS	1410911	1
5 m	SAC-5P-5,0-E20/M12FS	1410912	1
10 m	SAC-5P-10,0-E20/M12FS	1410913	1
2 m	SAC-5P-2,0-E20/M12FR	1410914	1
5 m	SAC-5P-5,0-E20/M12FR	1410915	1
10 m	SAC-5P-10,0-E20/M12FR	1410917	1

Sensor/actuator cable, 5-position, PVC



Common technical data	
Rated voltage	48 V AC / 60 V DC
Rated current	4 A
Contact material	CuSn
Contact surface material	Ni/Au
Material of grip body	TPU, hardly inflammable, self-extinguishing
Status indication	No
Degree of protection	IP65
Temperature data	-25 °C ... 90 °C
Plug/socket	

Cable length	Type	Item No.	Pcs./Pkt.
0.6 m	SAC-5P-M12MR/0,6-E20/M12FR	1410918	1
1 m	SAC-5P-M12MR/1,0-E20/M12FR	1410919	1
2 m	SAC-5P-M12MR/2,0-E20/M12FR	1410920	1
5 m	SAC-5P-M12MR/5,0-E20/M12FR	1410921	1
0.6 m	SAC-5P-M12MS/0,6-E20/M12FS	1410922	1
1 m	SAC-5P-M12MS/1,0-E20/M12FS	1410923	1
2 m	SAC-5P-M12MS/2,0-E20/M12FS	1410924	1
5 m	SAC-5P-M12MS/5,0-E20/M12FS	1410925	1



# Sensor/actuator cabling

## Sensor/actuator cable

### Sensor/actuator cable, 3-position, PUR



Common technical data	
Rated voltage	48 V AC / 60 V DC
Rated current	4 A
Contact material	CuSn
Contact surface material	Ni/Au
Material of grip body	TPU, hardly inflammable, self-extinguishing
Status indication	No
Degree of protection	IP65
Temperature data	-25 °C ... 90 °C
Plug/socket	

Cable length	Type	Item No.	Pcs./Pkt.
2 m	SAC-3P-M 8MS/ 2,0-E10	1411770	1
5 m	SAC-3P-M 8MS/ 5,0-E10	1411771	1
10 m	SAC-3P-M 8MS/10,0-E10	1411772	1
2 m	SAC-3P-M 8MR/ 2,0-E10	1411773	1
5 m	SAC-3P-M 8MR/ 5,0-E10	1411774	1
10 m	SAC-3P-M 8MR/ 10,0-E10	1411775	1

### Sensor/actuator cable, 3-position, PUR



Common technical data	
Rated voltage	48 V AC / 60 V DC
Rated current	4 A
Contact material	CuSn
Contact surface material	Ni/Au
Material of grip body	TPU, hardly inflammable, self-extinguishing
Status indication	No
Degree of protection	IP65
Temperature data	-25 °C ... 90 °C
Plug/socket	

Cable length	Type	Item No.	Pcs./Pkt.
2 m	SAC-3P- 2,0-E10/M 8FS	1411776	1
5 m	SAC-3P- 5,0-E10/M 8FS	1411777	1
10 m	SAC-3P-10,0-E10/M 8FS	1411778	1
2 m	SAC-3P- 2,0-E10/M 8FR	1411779	1
5 m	SAC-3P- 5,0-E10/M 8FR	1411780	1
10 m	SAC-3P-10,0-E10/M 8FR	1411781	1

### Sensor/actuator cable, 3-position, PUR



Common technical data	
Rated voltage	48 V AC / 60 V DC
Rated current	4 A
Contact material	CuSn
Contact surface material	Ni/Au
Material of grip body	TPU, hardly inflammable, self-extinguishing
Status indication	No
Degree of protection	IP65
Temperature data	-25 °C ... 90 °C
Plug/socket	

Cable length	Type	Item No.	Pcs./Pkt.
0.6 m	SAC-3P-M 8MR/0,6-E10/M 8FR	1411782	1
1 m	SAC-3P-M 8MR/1,0-E10/M 8FR	1411783	1
2 m	SAC-3P-M 8MR/2,0-E10/M 8FR	1411784	1
5 m	SAC-3P-M 8MR/5,0-E10/M 8FR	1411785	1
0.6 m	SAC-3P-M 8MS/0,6-E10/M 8FS	1411786	1
1 m	SAC-3P-M 8MS/1,0-E10/M 8FS	1411787	1
2 m	SAC-3P-M 8MS/2,0-E10/M 8FS	1411788	1
5 m	SAC-3P-M 8MS/5,0-E10/M 8FS	1411789	1



Sensor/actuator cable, 3-position, PVC



Common technical data	
Rated voltage	48 V AC / 60 V DC
Rated current	4 A
Contact material	CuSn
Contact surface material	Ni/Au
Material of grip body	TPU, hardly inflammable, self-extinguishing
Status indication	No
Degree of protection	IP65
Temperature data	-25 °C ... 90 °C
Plug/socket	

Cable length	Type	Item No.	Pcs./Pkt.
2 m	SAC-3P-M 8MS/ 2,0-E20	1410926	1
5 m	SAC-3P-M 8MS/ 5,0-E20	1410927	1
10 m	SAC-3P-M 8MS/10,0-E20	1410928	1
2 m	SAC-3P-M 8MR/ 2,0-E20	1410930	1
5 m	SAC-3P-M 8MR/ 5,0-E20	1410931	1
10 m	SAC-3P-M 8MR/10,0-E20	1410933	1

Sensor/actuator cable, 3-position, PVC



Common technical data	
Rated voltage	48 V AC / 60 V DC
Rated current	4 A
Contact material	CuSn
Contact surface material	Ni/Au
Material of grip body	TPU, hardly inflammable, self-extinguishing
Status indication	No
Degree of protection	IP65
Temperature data	-25 °C ... 90 °C
Plug/socket	

Cable length	Type	Item No.	Pcs./Pkt.
2 m	SAC-3P- 2,0-E20/M 8FS	1410935	1
5 m	SAC-3P- 5,0-E20/M 8FS	1410936	1
10 m	SAC-3P-10,0-E20/M 8FS	1410937	1
2 m	SAC-3P- 2,0-E20/M 8FR	1410938	1
5 m	SAC-3P- 5,0-E20/M 8FR	1410939	1
10 m	SAC-3P-10,0-E20/M 8FR	1410940	1

Sensor/actuator cable, 3-position, PVC



Common technical data	
Rated voltage	48 V AC / 60 V DC
Rated current	4 A
Contact material	CuSn
Contact surface material	Ni/Au
Material of grip body	TPU, hardly inflammable, self-extinguishing
Status indication	No
Degree of protection	IP65
Temperature data	-25 °C ... 90 °C
Plug/socket	

Cable length	Type	Item No.	Pcs./Pkt.
0.6 m	SAC-3P-M 8MR/0,6-E20/M 8FR	1410941	1
1 m	SAC-3P-M 8MR/1,0-E20/M 8FR	1410942	1
2 m	SAC-3P-M 8MR/2,0-E20/M 8FR	1410943	1
5 m	SAC-3P-M 8MR/5,0-E20/M 8FR	1410944	1
0.6 m	SAC-3P-M 8MS/0,6-E20/M 8FS	1410946	1
1 m	SAC-3P-M 8MS/1,0-E20/M 8FS	1410947	1
2 m	SAC-3P-M 8MS/2,0-E20/M 8FS	1410948	1
5 m	SAC-3P-M 8MS/5,0-E20/M 8FS	1410949	1

# Sensor/actuator cabling

## Sensor/actuator cable

### Sensor/actuator cable, 4-position, PUR



Common technical data	
Rated voltage	48 V AC / 60 V DC
Rated current	4 A
Contact material	CuSn
Contact surface material	Ni/Au
Material of grip body	TPU, hardly inflammable, self-extinguishing
Status indication	No
Degree of protection	IP65
Temperature data	-25 °C ... 90 °C
Plug/socket	

Cable length	Type	Item No.	Pcs./Pkt.
2 m	SAC-4P-M 8MS/ 2,0-E10	1411790	1
5 m	SAC-4P-M 8MS/ 5,0-E10	1411791	1
10 m	SAC-4P-M 8MS/10,0-E10	1411792	1
2 m	SAC-4P-M 8MR/ 2,0-E10	1411793	1
5 m	SAC-4P-M 8MR/ 5,0-E10	1411794	1
10 m	SAC-4P-M 8MR/ 10,0-E10	1411795	1

### Sensor/actuator cable, 4-position, PUR



Common technical data	
Rated voltage	48 V AC / 60 V DC
Rated current	4 A
Contact material	CuSn
Contact surface material	Ni/Au
Material of grip body	TPU, hardly inflammable, self-extinguishing
Status indication	No
Degree of protection	IP65
Temperature data	-25 °C ... 90 °C
Plug/socket	

Cable length	Type	Item No.	Pcs./Pkt.
2 m	SAC-4P- 2,0-E10/M 8FS	1411796	1
5 m	SAC-4P- 5,0-E10/M 8FS	1411797	1
10 m	SAC-4P-10,0-E10/M 8FS	1411798	1
2 m	SAC-4P- 2,0-E10/M 8FR	1411799	1
5 m	SAC-4P- 5,0-E10/M 8FR	1411800	1
10 m	SAC-4P-10,0-E10/M 8FR	1411801	1

### Sensor/actuator cable, 4-position, PUR



Common technical data	
Rated voltage	48 V AC / 60 V DC
Rated current	4 A
Contact material	CuSn
Contact surface material	Ni/Au
Material of grip body	TPU, hardly inflammable, self-extinguishing
Status indication	No
Degree of protection	IP65
Temperature data	-25 °C ... 90 °C
Plug/socket	

Cable length	Type	Item No.	Pcs./Pkt.
0.6 m	SAC-4P-M 8MR/0,6-E10/M 8FR	1411802	1
1 m	SAC-4P-M 8MR/1,0-E10/M 8FR	1411803	1
2 m	SAC-4P-M 8MR/2,0-E10/M 8FR	1411804	1
5 m	SAC-4P-M 8MR/5,0-E10/M 8FR	1411805	1
0.6 m	SAC-4P-M 8MS/0,6-E10/M 8FS	1411806	1
1 m	SAC-4P-M 8MS/1,0-E10/M 8FS	1411807	1
2 m	SAC-4P-M 8MS/2,0-E10/M 8FS	1411808	1
5 m	SAC-4P-M 8MS/5,0-E10/M 8FS	1411809	1

Sensor/actuator cable, 4-position, PVC



Common technical data	
Rated voltage	48 V AC / 60 V DC
Rated current	4 A
Contact material	CuSn
Contact surface material	Ni/Au
Material of grip body	TPU, hardly inflammable, self-extinguishing
Status indication	No
Degree of protection	IP65
Temperature data	-25 °C ... 90 °C
Plug/socket	

Cable length	Type	Item No.	Pcs./Pkt.
2 m	SAC-4P-M 8MS/ 2,0-E20	1410950	1
5 m	SAC-4P-M 8MS/ 5,0-E20	1410951	1
10 m	SAC-4P-M 8MS/10,0-E20	1410952	1
2 m	SAC-4P-M 8MR/ 2,0-E20	1410953	1
5 m	SAC-4P-M 8MR/ 5,0-E20	1410954	1
10 m	SAC-4P-M 8MR/10,0-E20	1410955	1

Sensor/actuator cable, 4-position, PVC



Common technical data	
Rated voltage	48 V AC / 60 V DC
Rated current	4 A
Contact material	CuSn
Contact surface material	Ni/Au
Material of grip body	TPU, hardly inflammable, self-extinguishing
Status indication	No
Degree of protection	IP65
Temperature data	-25 °C ... 90 °C
Plug/socket	

Cable length	Type	Item No.	Pcs./Pkt.
2 m	SAC-4P- 2,0-E20/M 8FS	1410956	1
5 m	SAC-4P- 5,0-E20/M 8FS	1410957	1
10 m	SAC-4P-10,0-E20/M 8FS	1410959	1
2 m	SAC-4P- 2,0-E20/M 8FR	1410960	1
5 m	SAC-4P- 5,0-E20/M 8FR	1410961	1
10 m	SAC-4P-10,0-E20/M 8FR	1410962	1

Sensor/actuator cable, 4-position, PVC



Common technical data	
Rated voltage	48 V AC / 60 V DC
Rated current	4 A
Contact material	CuSn
Contact surface material	Ni/Au
Material of grip body	TPU, hardly inflammable, self-extinguishing
Status indication	No
Degree of protection	IP65
Temperature data	-25 °C ... 90 °C
Plug/socket	

Cable length	Type	Item No.	Pcs./Pkt.
0.6 m	SAC-4P-M 8MR/0,6-E20/M 8FR	1410963	1
1 m	SAC-4P-M 8MR/1,0-E20/M 8FR	1410964	1
2 m	SAC-4P-M 8MR/2,0-E20/M 8FR	1410965	1
5 m	SAC-4P-M 8MR/5,0-E20/M 8FR	1410966	1
0.6 m	SAC-4P-M 8MS/0,6-E20/M 8FS	1410967	1
1 m	SAC-4P-M 8MS/1,0-E20/M 8FS	1410968	1
2 m	SAC-4P-M 8MS/2,0-E20/M 8FS	1410969	1
5 m	SAC-4P-M 8MS/5,0-E20/M 8FS	1410970	1

# Marking and labeling



## Marking and labeling

Our range is optimally tailored to your needs: Standard marking with pre-printed labels or individual labeling using our printing systems. Alternatively, you can use our marking service: Simply place your order via e-mail.

## Product range overview

Marking systems	<b>124</b>
Terminal marking	<b>126</b>
Conductor and cable marking	<b>127</b>
Device marking	<b>128</b>



**Reliable under all conditions**



Marking materials and their markings must remain intact, regardless of the area of application.

To ensure clear and permanent marking, the properties of the base material may not change too drastically. The quality of the marking must remain constant. In addition to environmental influences, marking materials and their markings are often subjected to mechanical influences. It must not be possible to scratch the marking off, and abrasions caused by industrial cleaning agents must not render the marking illegible.

Furthermore, the marking materials must also be securely fixed even when subjected to vibration.

Phoenix Contact only uses tested materials that fulfill the requirements set by these standards without limitations.



**DIN EN ISO 4892-2**

To simulate several years of use outdoors, the marking materials are exposed to cyclical stresses through UV radiation and humidity. This artificial weathering provides an insight into the mechanical properties and the appearance of a material.



**DIN EN ISO 175**

Liquid oils and chemicals can trigger physical or chemical reactions that have a negative impact on the base material or the marking. Tested materials stand up to these influences.



**DIN EN ISO 61010-1 and DIN EN 62208**

To ensure that the markings are wipe-resistant, cloths soaked in with isopropanol, n-hexane and petroleum ether are wiped over the marking material at a defined force for 30 seconds. After the test, the marking has to be clearly legible.



#### DIN 50018

To test the resistance of the materials against corrosion damage, they are exposed to a condensation changing climate with an atmosphere containing sulfur dioxide at +40 °C. This environment forms an acidic atmosphere during the test. Finally, a microscopic visual inspection of the materials is performed.



#### IEC 60068-2-11/-52

Particularly in ship building and in offshore applications, the markings must resist corrosive atmospheres containing salt. To ensure this can be achieved, the resistance of the materials is tested through salt spray in a corrosive atmosphere. A visual inspection is performed after the test.



#### DIN EN ISO 1518

The scratch resistance of markings is tested under intermittent or linear stress. A defined force is applied to an engraving needle via spring tension. The spring tension at which the Erichsen hardness tester leaves behind a barely visible trace is crucial.



#### DIN EN ISO 2409

To test the adhesive strength of printed materials, a transparent strip of self-adhesive tape with an adhesive strength of  $10 \pm 1$  N is applied to the printed materials to be tested. The self-adhesive tape is then pulled off at an angle of 60° to the direction of tensile force. There may be no marks from the printed materials on the adhesive tape after the test.



#### FINAT 1, 2, and 9

To determine the adhesive strength of a label on a base material, a strip of labels (25 mm x 175 mm) is applied with a specified force. After a defined waiting period, the test sample is then removed at a predefined angle, at 300 mm/min. The adhesive strength is specified in N/25 mm.



#### DIN EN 60529/ISO 20653

Differing ambient conditions and requirements necessitate a clear classification of markings in IP degrees of protection. These are expressed by two key figures following the IP abbreviation: the first figure describes the scope of protection against the ingress of foreign bodies, the second the seal-tightness against humidity.

## Thermal transfer printing systems

The proven thermal transfer printer technology is ideal for creating markings flexibly and reliably. Phoenix Contact offers you compact systems for printing materials in card or roll format, and a versatile handheld printer for marking directly on site.



### Thermal transfer printer for sheet and card material

THERMOMARK CARD 2.0 prints markers in card format for top quality terminal, wire, cable, equipment and plant marking applications. You can easily create high-quality printed labels and markers.



Technical data	
Width / Length / Height	254 mm / 325 mm / 194 mm
Weight	6 kg
Temperature range	5 °C ... 35 °C
Print resolution	300 dpi
Print width	104 mm
Interfaces	10/100 Mbps Ethernet, USB 2.0
Power supply	100 V AC ... 240 V AC / 50 Hz ... 60 Hz
Operating system	MS Windows Vista, MS Windows 7 (32/64-bit), MS Windows 8 (32/64-bit), MS Windows 8.1 (32/64-bit), MS Windows 10 (32/64-bit), Server 2008, Server 2008 R2, Server 2012, Server 2012 R2

Type	Item No.	Pcs./Pkt.
THERMOMARK CARD 2.0	1085267	1

Accessories	Type	Item No.	Pcs./Pkt.
Magazine, For THERMOMARK CARD and THERMOMARK PRIME, for accommodating US cards	TMP-US-MAG1	0803341	1
Magazine for the THERMOMARK CARD printer, for accommodating UM material (UM1-TM and UM5-TM)	TMP-UM-MAG1	0831200	1
Magazine for the THERMOMARK CARD printer, for accommodating UM material (UM-TMF)	TMP-UM-MAG2	0831201	1
Magazine for the THERMOMARK CARD printer, for accommodating UM material (UM1-TMF)	TMP-UM-MAG3	0831202	1
Magazine, for the THERMOMARK PRIME and the THERMOMARK CARD, for accommodating UCT-TM..., UCT1(U)-TM..., UCT5-TM..., UCT-EM (5x10), UCT-EM (6x10)	TMP-UCT-MAG1	0803342	1
Magazine, for the THERMOMARK PRIME and the THERMOMARK CARD, for accommodating UCT-TMF...	TMP-UCT-MAG2	0803343	1
Magazine, for the THERMOMARK PRIME and the THERMOMARK CARD, for accommodating UCT-WMCO ... (12x4)	TMP-UCT-MAG25	0803369	1
Magazine, for the THERMOMARK PRIME and the THERMOMARK CARD, for accommodating UCT-WMCO ... (18x4)	TMP-UCT-MAG28	0803372	1

### Thermal transfer printer for material off the roll

The THERMOMARK ROLL 2.0 prints markers in roll format for top quality terminal, wire, cable, equipment, and plant marking applications. You can easily create high-quality printed labels and markers.



Technical data	
Width / Length / Height	240 mm / 320 mm / 189 mm
Weight	3.8 kg
Temperature range	10 °C ... 35 °C
Print resolution	300 dpi
Print width	105 mm
Interfaces	10/100 Mbps Ethernet, USB 2.0, RS-232
Power supply	100 V AC ... 240 V AC / 50 Hz ... 60 Hz
Operating system	MS Windows Vista, MS Windows 7 (32/64-bit), MS Windows 8 (32/64-bit), MS Windows 8.1 (32/64-bit), MS Windows 10 (32/64-bit), Server 2008, Server 2008 R2, Server 2012, Server 2012 R2

Type	Item No.	Pcs./Pkt.
THERMOMARK ROLL 2.0	1085260	1

Accessories	Type	Item No.	Pcs./Pkt.
Cutter	THERMOMARK ROLL-CUTTER/P	5146435	1
Media hub	THERMOMARK ROLL-ERH	5146448	1
Ink ribbon, length , width 110 mm, ink color black	THERMOMARK-RIBBON 110	5145384	1
Ink ribbon, length , width 110 mm, ink color black	THERMOMARK-RIBBON 110-WMTB HF	5148007	1
Ink ribbon, length , width 110 mm, ink color black	THERMOMARK-RIBBON 110-WMSU	0801358	1
Ink ribbon, length , width 110 mm, ink color white	THERMOMARK-RIBBON 110-WMSU WH	0801359	1



### Mobile thermal transfer printer for roll material

The THERMOFOX handheld printer is ideally suited to fast marking on site. The thermal transfer printer is robust, easy to use, and offers versatile functions. It processes continuous media for terminal blocks, cables and conductors, equipment marking, and plant marking.



Technical data	
Width / Length / Height	98 mm / 230 mm / 69 mm
Weight	656 g
Temperature range	5 °C ... 40 °C
Print resolution	203 dpi
Print width	24 mm
Interfaces	USB
Power supply	100 V AC ... 240 V AC / 50 Hz ... 60 Hz
Operating system	MS Windows 7, MS Windows 8.1, MS Windows 10

Type	Item No.	Pcs./Pkt.
THERMOFOX	0803984	1

### Plotter set

Beginner's set, complete, consisting of: CMS-MARK-WIN marking software, CMS-P1-PLOTTER, magazine (e.g., for ZB, ZBF, PABA und GPE...), CMS-INK-WS-C5 ink and cleaning set



Technical data	
Width / Length / Height	440 mm / 660 mm / 125 mm
Weight	8 kg
Print resolution	0.01 mm
Power supply	
Set consists of	Marking plotter: CMS-P1-PLOTTER Magazine insert: CMS-P1-M/ZB Magazine insert: CMS-P1-M/ZBF Magazine insert: CMS-P1-M/PAB Magazine insert: CMS-P1-M/GPE Marker pen: CMS-PEN 0,25 Ink cartridge: CMS-INK-WS-C 5 Cleaning set: CMS-R-SET-WO Software: CMS-MARK-WIN

Type	Item No.	Pcs./Pkt.
CMS-P1-PLOTTER-KIT	5144628	1

### Marker pen for manual marking

Marker pen for manually marking unprinted zack marker strips, marking indelible and waterproof, line thickness 0.5 mm



Technical data	
Certification	CE
Color	black

Type	Item No.	Pcs./Pkt.
B-STIFT	1051993	10

### Software

Intuitive planning and marking software for configuring terminal strips and for professional marking of marking materials for terminal blocks, conductors, cables, devices, and systems. The software is available for download



Technical data	
Basic functions	Fully automatic generation of complete terminal strips from EPLAN 5 Data transfer to MS-Excel® and MS-Word® Export of marking data to the PROJECT complete marking software CSV and XML interface Internet update
Software interface	EPLAN Electric P8 / AUCOTEC ELCAD / AUCOTEC Engineering Base / AUCOTEC RUPLAN / ZUKEN E³ / Bentley Promis-e / WSCAD / IGE XAO / PC-Schematic AUTOMATION / SDProget SPAC
Operating system	MS Windows 10 (32/64-bit)

Type	Item No.	Pcs./Pkt.
PROJECT COMPLETE	1050453	1



## Marking material for terminal blocks

Large-surface and clear labeling of terminal strips is indispensable for quick and error-free wiring of terminal strips. This is also true for the maintenance and startup of control cabinets and systems. Terminal markers from Phoenix Contact are ideally adapted to the terminals and are offered without labeling in card or roll form.

### Terminal marking, Mounting type: clip on, tall marker groove



Common technical data	
Material	PC
Flammability rating according to UL 94	V2
Ambient temperature (operation)	-40 °C ... 120 °C
Wipe resistance	DIN EN 61010-1 (VDE 0411-1)
Components	free from silicone, halogen, and cadmium
Color	white

Lettering field size	Labels per card	Type	Item No.	Pcs./Pkt.
3.5 x 10 mm	34	UM-TM (3,5X10)	0830952	10
4 x 10 mm	28	UM-TM (4X10)	0830940	10
5 x 10 mm	24	UM-TM (5X10)	0830913	10
6 x 10 mm	20	UM-TM (6X10)	0830908	10
8 x 10 mm	14	UM-TM (8X10)	0830918	10
10 x 10 mm	12	UM-TM (10X10)	0830914	10
12 x 10 mm	10	UM-TM (12X10)	0830937	10
16 x 10 mm	8	UM-TM (16X10)	0830941	10

Accessories	Type	Item No.	Pcs./Pkt.
Magazine for the THERMOMARK CARD printer, for accommodating UM material (UM1-TM and UM5-TM)	TMP-UM-MAG1	0831200	1

### Terminal marking, Mounting type: clip on, flat marker groove



Common technical data	
Material	PC
Flammability rating according to UL 94	V2
Ambient temperature (operation)	-40 °C ... 120 °C
Wipe resistance	DIN EN 61010-1 (VDE 0411-1)
Components	free from silicone, halogen, and cadmium
Color	white

Lettering field size	Labels per card	Type	Item No.	Pcs./Pkt.
3.5 x 5 mm	34	UM-TMF (3,5X5)	0830953	10
4 x 5 mm	28	UM-TMF (4X5)	0830942	10
5 x 5 mm	24	UM-TMF (5X5)	0830927	10
5 x 10 mm	24	UM-TMF (5X10)	0830930	10
6 x 5 mm	20	UM-TMF (6X5)	0830944	10
6 x 10 mm	20	UM-TMF (6X10)	0830947	10
8 x 5 mm	14	UM-TMF (8X5)	0830951	10
10 x 5 mm	12	UM-TMF (10X5)	0830949	10
12 x 5 mm	10	UM-TMF (12X5)	0830948	10
16 x 5 mm	8	UM-TMF (16X5)	0830950	10

Accessories	Type	Item No.	Pcs./Pkt.
Magazine for the THERMOMARK CARD printer, for accommodating UM material (UM-TMF)	TMP-UM-MAG2	0831201	1



## Marking material for conductors and cables

Clear and permanent marking of all conductors and cables considerably improves transparency in control cabinets and switchgear. It makes assembly and maintenance work easier and assists in rectifying faults.

### Conductor marking, Mounting type: slide-on



#### Common technical data

Can be labeled using	THERMOMARK E.300 D • THERMOMARK E.600 D • THERMOMARK E.300 D AR • THERMOMARK E.300 D CN • THERMOMARK E.300 D US • THERMOMARK E.600 D AR • THERMOMARK E.600 D CN • THERMOMARK E.600 D US • THERMOMARK E.300 • THERMOMARK E.300 AR • THERMOMARK E.300 CN • THERMOMARK ROLL 2.0 • THERMOMARK ROLL 2.0 AR • THERMOMARK ROLL 2.0 CN • THERMOMARK ROLL • THERMOMARK ROLL AR • THERMOMARK ROLL CN • THERMOMARK ROLL X1 • THERMOMARK ROLLMASTER 300 • THERMOMARK ROLLMASTER 600 • THERMOMARK ROLLMASTER 300 CN • THERMOMARK ROLLMASTER 600 CN • THERMOMARK X1.2 • THERMOMARK W2
Material	Polyolefine
Flammability rating according to UL 94	V0
Ambient temperature (operation)	-30 °C ... 125 °C
Wipe resistance	DIN EN 61010-1 (VDE 0411-1)
Components	halogen-free
Color	white

#### Lettering field size

	Type	Item No.	Pcs./Pkt.
4 x 30000 mm	WMS-OT HF 2,4 (EX4)R	1163127	1
4 x 120000 mm	WMS-OT HF 2,4 (EX4)RL	1163116	1
5 x 30000 mm	WMS-OT HF 3,2 (EX5)R	1044236	1

#### Accessories

	Type	Item No.	Pcs./Pkt.
Ink ribbon, length , width 25 mm, ink color black	TM-RIBBON 25 BK 102	1053499	1



## Marking material for devices

Identifying electrical and electronic control cabinets does not just make service work easier. In some sectors, it is actually a mandatory requirement. Moreover, equipment identification improves the quality of the control cabinets and systems.

### Device marking, Mounting type: adhesive



#### Common technical data

Can be labeled using	BLUEMARK ID COLOR • BLUEMARK ID • THERMOMARK PRIME • THERMOMARK PRIME CN • THERMOMARK CARD 2.0 • THERMOMARK CARD 2.0 AR • THERMOMARK CARD 2.0 CN • THERMOMARK CARD • THERMOMARK CARD AR • THERMOMARK CARD CN
Material	PVC
Ambient temperature (operation)	-30 °C ... 80 °C
Wipe resistance	DIN EN 61010-1 (VDE 0411-1)
Components	Silicone-free

Lettering field size	Labels per card	Color	Type	Item No.	Pcs./Pkt.
8.8 x 15 mm	88	white	US-EMLP (8,8X15)	0830303	10
8.8 x 15 mm	88	silver	US-EMLP (8,8X15) SR	0830317	10
8.8 x 15 mm	88	yellow	US-EMLP (8,8X15) YE	0830316	10
11 x 9 mm	135	white	US-EMLP (11X9)	0828789	10
11 x 9 mm	135	silver	US-EMLP (11X9) SR	0828872	10
11 x 9 mm	135	yellow	US-EMLP (11X9) YE	0828871	10
15 x 5 mm	189	white	US-EMLP (15X5)	0828790	10
15 x 5 mm	189	silver	US-EMLP (15X5) SR	0828874	10
15 x 5 mm	189	yellow	US-EMLP (15X5) YE	0828873	10
17.5 x 15 mm	45	white	US-EMLP (17,5X15)	0830839	10
17 x 15 mm	54	white	US-EMLP (17X15)	0828793	10
17 x 15 mm	54	silver	US-EMLP (17X15) SR	0828880	10
17 x 15 mm	54	yellow	US-EMLP (17X15) YE	0828879	10
17 x 7 mm	114	white	US-EMLP (17X7)	0828792	10
17 x 7 mm	114	silver	US-EMLP (17X7) SR	0828878	10
17 x 7 mm	114	yellow	US-EMLP (17X7) YE	0828877	10
20 x 9 mm	75	white	US-EMLP (20X9)	0828795	10
20 x 9 mm	75	silver	US-EMLP (20X9) SR	0828884	10
20 x 9 mm	75	yellow	US-EMLP (20X9) YE	0828883	10
22 x 22 mm	24	white	US-EMLP (22X22)	0828796	10
22 x 22 mm	24	silver	US-EMLP (22X22) SR	0828886	10
22 x 22 mm	24	yellow	US-EMLP (22X22) YE	0828885	10
27 x 12.5 mm	30	white	US-EMLP (27X12,5)	0828798	10
27 x 12.5 mm	30	silver	US-EMLP (27X12,5) SR	0828892	10
27 x 12.5 mm	30	yellow	US-EMLP (27X12,5) YE	0828891	10
27 x 15 mm	27	white	US-EMLP (27X15)	0828799	10
27 x 15 mm	27	silver	US-EMLP (27X15) SR	0828894	10
27 x 15 mm	27	yellow	US-EMLP (27X15) YE	0828893	10
27 x 18 mm	21	white	US-EMLP (27X18)	0828800	10
27 x 18 mm	21	silver	US-EMLP (27X18) SR	0828896	10
27 x 18 mm	21	yellow	US-EMLP (27X18) YE	0828895	10
27 x 27 mm	15	white	US-EMLP (27X27)	0828801	10
27 x 27 mm	15	silver	US-EMLP (27X27) SR	0828898	10
27 x 27 mm	15	yellow	US-EMLP (27X27) YE	0828897	10
27 x 8 mm	51	white	US-EMLP (27X8)	0828797	10
27 x 8 mm	51	silver	US-EMLP (27X8) SR	0828890	10
27 x 8 mm	51	yellow	US-EMLP (27X8) YE	0828889	10
35 x 15 mm	27	white	US-EMLP (35X15)	0830300	10
35 x 15 mm	27	silver	US-EMLP (35X15) SR	0830320	10
35 x 15 mm	27	yellow	US-EMLP (35X15) YE	0830319	10
35 x 9 mm	45	white	US-EMLP (35X9)	0828802	10
35 x 9 mm	45	silver	US-EMLP (35X9) SR	0829430	10
35 x 9 mm	45	yellow	US-EMLP (35X9) YE	0828899	10
40 x 10 mm	26	white	US-EMLP (40X10)	0830341	10
40 x 10 mm	26	silver	US-EMLP (40X10) SR	0830328	10
40 x 10 mm	26	yellow	US-EMLP (40X10) YE	0830342	10
49 x 15 mm	18	white	US-EMLP (49X15)	0828803	10
49 x 15 mm	18	silver	US-EMLP (49X15) SR	0828902	10
49 x 15 mm	18	yellow	US-EMLP (49X15) YE	0828901	10
52.5 x 15 mm	16	white	US-EMLP (52,5X15)	0830301	10

Accessories	Type	Item No.	Pcs./Pkt.
Magazine for the THERMOMARK CARD printer, for accommodating US cards	THERMOMARK CARD-US-MAG1	5146451	1

### Device marking, Mounting type: adhesive



#### Common technical data

Can be labeled using	BLUEMARK ID COLOR • BLUEMARK ID • THERMOMARK PRIME • THERMOMARK PRIME CN • THERMOMARK CARD 2.0 • THERMOMARK CARD 2.0 AR • THERMOMARK CARD 2.0 CN • THERMOMARK CARD • THERMOMARK CARD AR • THERMOMARK CARD CN
Material	PVC
Ambient temperature (operation)	-30 °C ... 80 °C
Wipe resistance	DIN EN 61010-1 (VDE 0411-1)
Components	Silicone-free

Lettering field size	Labels per card	Color	Type	Item No.	Pcs./Pkt.
60 x 30 mm	4	yellow	US-EMLP (60X30) YE	0828905	10
70 x 15 mm	9	white	US-EMLP (70X15)	0830302	10
70 x 15 mm	9	silver	US-EMLP (70X15) SR	0830326	10
70 x 15 mm	9	yellow	US-EMLP (70X15) YE	0830325	10
85.6 x 54 mm	2	white	US-EMLP (85,6X54)	0828806	10
85.6 x 54 mm	2	silver	US-EMLP (85,6X54) SR	0828908	10
85.6 x 54 mm	2	yellow	US-EMLP (85,6X54) YE	0828907	10
100 x 60 mm	2	white	US-EMLP (100X60)	0828807	10
100 x 60 mm	2	silver	US-EMLP (100X60) SR	0828910	10
100 x 60 mm	2	yellow	US-EMLP (100X60) YE	0828909	10
104 x 135 mm	1	white	US-EMLP (104X135)	0830304	10
104 x 135 mm	1	silver	US-EMLP (104X135) SR	0830306	10
104 x 135 mm	1	yellow	US-EMLP (104X135) YE	0830305	10

#### Accessories

Magazine for the THERMOMARK CARD printer, for accommodating US cards	Type	Item No.	Pcs./Pkt.
	THERMOMARK CARD-US-MAG1	5146451	1

### Device marking, Mounting type: adhesive



#### Common technical data

Can be labeled using	THERMOMARK E.300 D • THERMOMARK E.600 D • THERMOMARK E.300 D AR • THERMOMARK E.300 D CN • THERMOMARK E.300 D US • THERMOMARK E.600 D AR • THERMOMARK E.600 D CN • THERMOMARK E.600 D US • THERMOMARK E.300 • THERMOMARK E.300 AR • THERMOMARK E.300 CN • THERMOMARK ROLL 2.0 • THERMOMARK ROLL 2.0 AR • THERMOMARK ROLL 2.0 CN • THERMOMARK ROLL • THERMOMARK ROLL AR • THERMOMARK ROLL CN • THERMOMARK ROLL X1 • THERMOMARK ROLLMASTER 300 • THERMOMARK ROLLMASTER 600 • THERMOMARK ROLLMASTER 300 CN • THERMOMARK ROLLMASTER 600 CN • THERMOMARK X1.2
Material	Polyester
Ambient temperature (operation)	-40 °C ... 150 °C
Wipe resistance	DIN EN 61010-1 (VDE 0411-1)
Components	free from silicone and halogen

Lettering field size	Labels per roll	Color	Type	Item No.	Pcs./Pkt.
10 x 4 mm	10000	white	EML (10X4)R	0815583	1
10 x 7 mm	10000	white	EML (10X7)R	0816663	1
10 x 7 mm	10000	yellow	EML (10X7)R YE	0816676	1
15 x 6 mm	2500	yellow	EML (15X6)R YE	0819288	1
15 x 6 mm	2500	white	EML (15X6)R	0803275	1
15 x 9 mm	2500	white	EML (15X9)R	0815677	1
15 x 9 mm	2500	yellow	EML (15X9)R YE	0816045	1
16.5 x 5 mm	2500	white	EML (16,5X5)R	0816702	1
16.5 x 5 mm	2500	yellow	EML (16,5X5)R YE	0816728	1
16 x 7 mm	10000	white	EML (16X7)R	0818001	1
16 x 7 mm	10000	yellow	EML (16X7)R YE	0816731	1
17.5 x 8 mm	2500	white	EML (17,5X8)R	0816744	1
17.5 x 8 mm	2500	yellow	EML (17,5X8)R YE	0816757	1
19 x 6 mm	2500	white	EML (19X6)R	0816760	1
19 x 6 mm	2500	yellow	EML (19X6)R YE	0800107	1
20 x 7 mm	2500	yellow	EML (20X7)R YE	0816773	1
20 x 8 mm	2500	white	EML (20X8)R	0816786	1
20 x 8 mm	2500	yellow	EML (20X8)R YE	0816799	1
24 x 3 mm	2500	white	EML (24X3)R	0830291	1
24 x 4 mm	1000	white	EML (24X4)R	0800061	1
24 x 4 mm	1000	yellow	EML (24X4)R YE	0803683	1
25.4 x 12.7 mm	2500	white	EML (25,4X12,7)R	0816825	1
25.4 x 12.7 mm	2500	yellow	EML (25,4X12,7)R YE	0816838	1
26.5 x 17.5 mm	2500	yellow	EML (26,5X17,5)R YE	0816896	1
30 x 20 mm	2500	white	EML (30X20)R	0816922	1
30 x 20 mm	2500	yellow	EML (30X20)R YE	0816935	1
32 x 25 mm	1500	yellow	EML (32X25)R YE	0800020	1
36 x 25 mm	1000	white	EML (36X25)R	0803136	1
38 x 17 mm	2500	white	EML (38X17)R	0816951	1
40 x 6 mm	2500	white	EML (40X6)R	0830481	1

#### Accessories

Ink ribbon, length , width 110 mm, ink color black	Type	Item No.	Pcs./Pkt.
	THERMOMARK-RIBBON 110	5145384	1

# Marking and labeling

## Device marking

### Device marking, Mounting type: adhesive



#### Common technical data

Can be labeled using

THERMOMARK E.300 D • THERMOMARK E.600 D • THERMOMARK E.300 D AR • THERMOMARK E.300 D CN • THERMOMARK E.300 D US • THERMOMARK E.600 D AR • THERMOMARK E.600 D CN • THERMOMARK E.600 D US • THERMOMARK E.300 • THERMOMARK E.300 AR • THERMOMARK E.300 CN • THERMOMARK ROLL 2.0 • THERMOMARK ROLL 2.0 AR • THERMOMARK ROLL 2.0 CN • THERMOMARK ROLL • THERMOMARK ROLL AR • THERMOMARK ROLL CN • THERMOMARK ROLL X1 • THERMOMARK ROLLMASTER 300 • THERMOMARK ROLLMASTER 600 • THERMOMARK ROLLMASTER 300 CN • THERMOMARK ROLLMASTER 600 CN • THERMOMARK X1.2

Material

Polyester

Ambient temperature (operation)

-40 °C ... 150 °C

Wipe resistance

DIN EN 61010-1 (VDE 0411-1)

Components

free from silicone and halogen

Lettering field size	Labels per roll	Color	Type	Item No.	Pcs./Pkt.
40 x 6 mm	2500	yellow	EML (40X6)R YE	0830482	1
40 x 8 mm	1000	white	EML (40X8)R	0816980	1
40 x 8 mm	1000	yellow	EML (40X8)R YE	0803712	1
40 x 25 mm	1000	white	EML (40X25)R	0818027	1
40 x 25 mm	1000	yellow	EML (40X25)R YE	0816977	1
47 x 22 mm	1000	white	EML (47X22)R	0803907	1
50 x 10 mm	2500	white	EML (50X10)R	0830483	1
50 x 10 mm	2500	yellow	EML (50X10)R YE	0830484	1
51 x 25 mm	1000	white	EML (51X25)R	0817028	1
51 x 25 mm	1000	yellow	EML (51X25)R YE	0817031	1
70 x 32 mm	1000	white	EML (70X32)R	0817060	1
70 x 32 mm	1000	yellow	EML (70X32)R YE	0817073	1
70 x 50 mm	400	white	EML (70X50)R	0817099	1
75 x 10 mm	2500	white	EML (75X10)R	0830485	1
75 x 10 mm	2500	yellow	EML (75X10)R YE	0830486	1
80 x 20 mm	1000	white	EML (80X20)R	0803138	1
90 x 5 mm	2500	white	EML (90X5)R	0817109	1
100 x 30 mm	500	yellow	EML (100X30)R YE	0801816	1
100 x 40 mm	300	white	EML (100X40)R	0800286	1
100 x 73 mm	300	white	EML (100X73)R	0817125	1
100 x 73 mm	300	yellow	EML (100X73)R YE	0817138	1
100 x 90 mm	250	white	EML (100X90)R	0817154	1
105 x 23 mm	1000	white	EML (105X23)R	0803137	1

#### Accessories

Ink ribbon, length , width 110 mm, ink color black

Type

THERMOMARK-RIBBON 110

Item No.  
5145384

Pcs./Pkt.  
1

### Device marking, Mounting type: adhesive



#### Common technical data

Can be labeled using

THERMOMARK E.300 D • THERMOMARK E.600 D • THERMOMARK E.300 D AR • THERMOMARK E.300 D CN • THERMOMARK E.300 D US • THERMOMARK E.600 D AR • THERMOMARK E.600 D CN • THERMOMARK E.600 D US • THERMOMARK E.300 • THERMOMARK E.300 AR • THERMOMARK E.300 CN • THERMOMARK ROLL 2.0 • THERMOMARK ROLL 2.0 AR • THERMOMARK ROLL 2.0 CN • THERMOMARK ROLL • THERMOMARK ROLL AR • THERMOMARK ROLL CN • THERMOMARK ROLL X1 • THERMOMARK ROLLMASTER 300 • THERMOMARK ROLLMASTER 600 • THERMOMARK ROLLMASTER 300 CN • THERMOMARK ROLLMASTER 600 CN • THERMOMARK X1.2

Material

Polyester

Ambient temperature (operation)

-40 °C ... 150 °C

Wipe resistance

DIN EN 61010-1 (VDE 0411-1)

Components

free from silicone and halogen

Lettering field size	Color	Type	Item No.	Pcs./Pkt.
continuous x 20 mm	white	EML (20XE)R	0803452	1
continuous x 20 mm	yellow	EML (20XE)R YE	0803453	1
70 x 40000 mm	white	EML (70XE)R	0803438	1
110 x 40000 mm	white	EML (110XE)R	0815596	1
110 x 40000 mm	yellow	EML (110XE)R YE	0815606	1

#### Accessories

Ink ribbon, length , width 110 mm, ink color black

Type

THERMOMARK-RIBBON 110

Item No.  
5145384

Pcs./Pkt.  
1

### Device marking, Mounting type: adhesive

The MM-EML... polyester self-adhesive labels are available as continuous media for equipment marking.



Common technical data	
Can be labeled using	THERMOFOX • THERMOFOX CN • THERMOFOX RU • THERMO-MARK GO • THERMOMARK GO.K
Material	Polyester
Ambient temperature (operation)	-40 °C ... 150 °C
Wipe resistance	DIN EN 61010-1 (VDE 0411-1)
Components	free from silicone, halogen, and cadmium

Lettering field size	Color	Type	Item No.	Pcs./Pkt.
continuous x 8 mm	silver/black	MM-EML (EX10)R C1 SR/BK	0803974	1
continuous x 8 mm	white/black	MM-EML (EX10)R C1 WH/BK	0803970	1
continuous x 10 mm	silver/black	MM-EML (EX12)R C1 SR/BK	0803975	1
continuous x 10 mm	white/black	MM-EML (EX12)R C1 WH/BK	0803971	1
continuous x 16 mm	silver/black	MM-EML (EX18)R C1 SR/BK	0803976	1
continuous x 16 mm	white/black	MM-EML (EX18)R C1 WH/BK	0803972	1
continuous x 22 mm	silver/black	MM-EML (EX24)R C1 SR/BK	0803978	1
continuous x 22 mm	white/black	MM-EML (EX24)R C1 WH/BK	0803973	1

# Tools and mounting material





## Tools and mounting material

Our tools and mounting materials portfolio includes a complete range of hand tools for industrial use. It thereby ensures that all tasks in the process chain can be performed professionally. Our hand tools are all about quality, precision, durability, and effectiveness.

## Product range overview

Tools	<b>136</b>
Mounting material	<b>139</b>

### Tool quality and expertise



Professional tools are characterized by their reliability and high performance. Phoenix Contact produces tools in highly specialized manufacturing processes in accordance with applicable standards, directives, and legal regulations. Conscious of our responsibility to the environment, production at our manufacturing site in Sweden conserves resources and is sustainable.

Phoenix Contact tools are characterized by innovative solutions, precision, and durability.



#### Cutting

Convenient and fatigue-free cutting: tools from the CUTFOX product range can process conductors and cables up to 1,400 mm<sup>2</sup> and up to 100 mm in diameter without crushing them. Only a very low force is necessary, thanks to the ratchet mechanism – even for large conductor cross sections up to 100 mm in diameter. The tools can even cut extremely hard materials such as piano wire and spring steel effortlessly and precisely.



#### Stripping

The corresponding removal or stripping tool removes the insulated areas professionally and quickly. The length of insulation to be removed varies depending on the terminal point or connector. This is set by means of adjustable limit stops. Phoenix Contact offers a wide range of stripping tools for convenient and safe processing of various conductor, line, and cable types.



#### Crimping

The term crimping describes the mechanical joining of the contact to the conductor. An unlockable pressure lock ensures that this connection is secure. It unlocks as soon as the required crimping pressure is applied. The user achieves consistent crimping results with maximum pull-out values. Phoenix Contact tests and adjusts all tools of the CRIMPFOX range of pliers in accordance with the applicable standards.



### Purchasing

Phoenix Contact places the highest requirements on quality: from the procurement of all raw materials and components for tools and automatic devices.

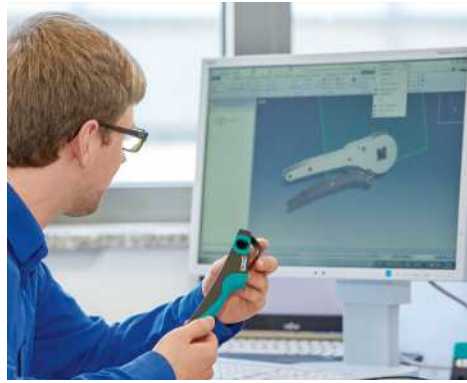

### Development

Phoenix Contact develops innovative products that impress. The focus during development is on ergonomics, user-friendliness, efficiency and safety.



### Production

Qualified experts deliver high-quality products. To this end, a comprehensive machine park and the most modern manufacturing processes are available.



### Quality assurance

Phoenix Contact guarantees the highest quality standards throughout the entire process chain. Regular checks are conducted using state-of-the-art test methods and test equipment to ensure compliance with these standards.



### Advice and service

Do you need support? Expert team members will be happy to advise you should you have any questions regarding products or applications.

### Your advantages:

- ✓ Durable, thanks to high-quality components and raw materials
- ✓ Functional and flexible use, thanks to the ergonomic design
- ✓ Everything from a single source, thanks to the comprehensive product range

## The right tool for every application

The TOOL fox tool range features processing and measuring tools for all electrical engineering applications. The ergonomically designed tools for cutting, stripping, and crimping are characterized by their optimum handling and quality.



### Diagonal cutter

Electrician's diagonal cutter, angled design, with stripping and crimp area, size: 180 mm



Technical data	
Cutting capacity	0.2 mm ... 11 mm / > 0 mm <sup>2</sup>
Grip casing	Multi-component sleeves
Length	180 mm

Type	Item No.	Pcs./Pkt.
CUTFOX-SE LM	1212833	1

### Cable-cutting tool

Cable cutter, for copper and aluminum up to 12 mm diameter (up to 35 mm<sup>2</sup>)



Technical data	
Cutting capacity	≤ 12 mm / ≤ 35 mm <sup>2</sup>
Ergonomic design	Suitable for right-handed use
Grip casing	Multi-component sleeves
Width	53 mm
Length	165 mm

Type	Item No.	Pcs./Pkt.
CUTFOX 12	1212128	1

### Cable-cutting tool

Cable cutter, angled, for copper and aluminum up to 18 mm diameter (up to 50 mm<sup>2</sup>)



Technical data	
Cutting capacity	≤ 18 mm / ≤ 50 mm <sup>2</sup>
Ergonomic design	Suitable for right-handed use
Grip casing	Multi-component sleeves
Width	50 mm
Length	180 mm

Type	Item No.	Pcs./Pkt.
CUTFOX 18	1212129	1

### Stripping tool

Multifunction stripping tool, for removing the jacket from cables with a diameter of 8 to 13 mm, for stripping cables with a cross section of 0.2 to 10 mm<sup>2</sup>, with full-fledged diagonal cutter, VDE 1000 V AC/1500 V DC tested



Technical data	
Grip casing	Multi-component sleeves
Length	190 mm
Conductor cross section	0.2 mm <sup>2</sup> ... 10 mm <sup>2</sup>
Stripping length	100 mm

Type	Item No.	Pcs./Pkt.
WIREFOX-MP VDE	1212528	1

### Stripping tool

Stripping pliers, for removing the sheath from cables up to 5 mm in diameter, for stripping conductors with a cross section of up to 10 mm<sup>2</sup>, scale for measuring the stripping length; VDE-tested.



Technical data	
Grip casing	Multi-component sleeves
Length	160 mm
Conductor cross section	0.2 mm <sup>2</sup> ... 10 mm <sup>2</sup>
Stripping length	18 mm

Type	Item No.	Pcs./Pkt.
WIREFOX 10 VDE	1212366	1

### Crimping pliers

Crimping pliers, for uninsulated and insulated ferrules, DIN 46228 Part 1 and 4, from 0.14 mm<sup>2</sup> ... 10 mm<sup>2</sup>, also for TWIN ferrules up to 2 x 4 mm<sup>2</sup>, automatic cross section adjustment, lateral insertion, equipped with fall protection



Technical data	
Max. cross section	10 mm <sup>2</sup>
Color	black/green
Type of contact	Insulated and uninsulated ferrules
Width	70 mm
Length	180 mm
Height	21 mm
Compression	Square crimp

Type	Item No.	Pcs./Pkt.
CRIMPFOX CENTRUS 10S	1213154	1

### Crimping pliers

Crimping pliers, for uninsulated and insulated ferrules, DIN 46228 Part 1 and 4, from 0.14 mm<sup>2</sup> ... 10 mm<sup>2</sup>, also for TWIN ferrules up to 2 x 4 mm<sup>2</sup>, automatic cross section adjustment, lateral insertion, equipped with fall protection



Technical data	
Max. cross section	10 mm <sup>2</sup>
Color	black/green
Type of contact	Insulated and uninsulated ferrules
Width	70 mm
Length	180 mm
Height	21 mm
Compression	HEX crimp

Type	Item No.	Pcs./Pkt.
CRIMPFOX CENTRUS 10H	1213156	1

# Tools and mounting material

## Tools

### Multi-function tool

Tool for processing ferrules according to DIN 46228-4, 0.5 mm<sup>2</sup> to 2.5 mm<sup>2</sup>, equipped with pressure lock, magazine, cutting, stripping, twisting, and crimping unit.



Technical data	
Max. cross section	2.5 mm <sup>2</sup>
Color	black
Type of contact	Ferrules
Width	31.5 mm
Length	180 mm
Height	100 mm
Compression	Indent crimp

Type	Item No.	Pcs./Pkt.
CRIMPFOX 4 IN 1	1200101	1

Accessories	Type	Item No.	Pcs./Pkt.
Ferrule magazine for CRIMPFOX 4 IN 1, for ferrules with insulating collars from 0.5 mm <sup>2</sup> ... 2.5 mm <sup>2</sup> , with a length of 8 mm	CRIMPFOX 4 IN 1/MAG	1200103	1

### Toolbox

Tool for processing ferrules according to DIN 46228-4, 0.5 mm<sup>2</sup> to 2.5 mm<sup>2</sup>, equipped with pressure lock, cutting, stripping, twisting, and crimping unit, with three magazines including a strip each of ferrules from 0.5 mm<sup>2</sup> ... 2.5 mm<sup>2</sup>, packaged in a robust plastic case



Technical data	
Max. cross section	2.5 mm <sup>2</sup>
Color	black
Type of contact	Ferrules
Width	31.5 mm
Length	180 mm
Height	100 mm
Compression	Indent crimp

Type	Item No.	Pcs./Pkt.
CRIMPFOX 4 IN 1 SET	1200102	1

Accessories	Type	Item No.	Pcs./Pkt.
Ferrule magazine for CRIMPFOX 4 IN 1, for ferrules with insulating collars from 0.5 mm <sup>2</sup> ... 2.5 mm <sup>2</sup> , with a length of 8 mm	CRIMPFOX 4 IN 1/MAG	1200103	1

### Crimping pliers

Crimping pliers, for ferrules without insulating collar according to DIN 46228 Part 1 and ferrules with insulating collar according to DIN 46228 Part 4, 0.25 mm<sup>2</sup> ... 6.0 mm<sup>2</sup>, lateral entry, trapezoidal crimp



Technical data	
Max. cross section	6 mm <sup>2</sup>
Color	black
Type of contact	Insulated and uninsulated ferrules
Width	18 mm
Length	198 mm
Height	59 mm
Compression	Trapezoidal crimp

Type	Item No.	Pcs./Pkt.
CRIMPFOX 6	1212034	1





### Ferrules

The ferrules with plastic sleeves are made from soft tin-plated electrolytic copper. They increase the insulation reliability of connections in close proximity to each other and prevent the splicing of wires.

#### Ferrule, With insulating collar

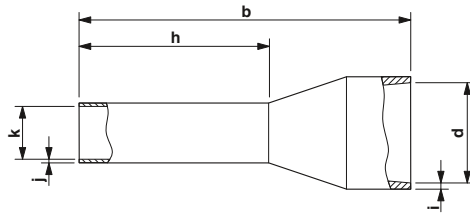

Common technical data	
Material / coating	CU-DHP / tin-plated (galvanic)
Plastic sleeve material	polypropylene
Long/short-term temperature	105 °C / 120 °C

Approvals	mm <sup>2</sup>	AWG	Color	b [mm]	d [mm]	h [mm]	i [mm]	j [mm]	k [mm]	Type	Item No.	Pcs./Pkt.
④	0.25	24	yellow	10.50	2.00	6.00	0.25	0.15	0.80	Al 0,25-6 YE	3203024	100
④	0.25	24	yellow	12.50	2.00	8.00	0.25	0.15	0.80	Al 0,25-8 YE	3203037	100
④	0.25	24	yellow	14.50	2.00	10.00	0.25	0.15	0.80	Al 0,25-10 YE	3241128	100
④	0.34	22	turquoise	10.50	2.00	6.00	0.25	0.15	0.80	Al 0,34-6 TQ	3203053	100
④	0.34	22	turquoise	12.50	2.00	8.00	0.25	0.15	0.80	Al 0,34-8 TQ	3203066	100
④	0.34	22	turquoise	14.50	2.00	10.00	0.25	0.15	0.80	Al 0,34-10 TQ	3241129	100
④	0.34	22	turquoise	16.50	2.00	12.00	0.25	0.15	0.80	Al 0,34-12 TQ	3200645	100
④	0.5	20	white	12.00	2.50	6.00	0.25	0.15	1.10	Al 0,5-6 WH	3200687	100
④	0.5	20	white	14.00	2.50	8.00	0.25	0.15	1.10	Al 0,5-8 WH	3200014	100
④	0.5	20	white	16.00	2.50	10.00	0.25	0.15	1.10	Al 0,5-10 WH	3201275	100
④	0.5	20	white	18.00	2.50	12.00	0.25	0.15	1.10	Al 0,5-12 WH	3200506	100
④	0.75	18	gray	12.00	2.80	6.00	0.25	0.15	1.30	Al 0,75-6 GY	3200690	100
④	0.75	18	gray	14.00	2.80	8.00	0.25	0.15	1.30	Al 0,75-8 GY	3200519	100
④	0.75	18	gray	16.00	2.80	10.00	0.25	0.15	1.30	Al 0,75-10 GY	3201288	100
④	0.75	18	gray	18.00	2.80	12.00	0.25	0.15	1.30	Al 0,75-12 GY	3200849	100
④	1	18	red	12.00	3.00	6.00	0.30	0.15	1.50	Al 1-6 RD	3200742	100
④	1	18	red	14.00	3.00	8.00	0.30	0.15	1.50	Al 1-8 RD	3200030	100
④	1	18	red	16.00	3.00	10.00	0.30	0.15	1.50	Al 1-10 RD	3200182	100
④	1	18	red	18.00	-	12.00	0.30	0.15	1.50	Al 1-12 RD	3200674	100
④	1.5	16	black	12.00	3.40	6.00	0.30	0.15	1.70	Al 1,5-6 BK	3200755	100
④	1.5	16	black	14.00	3.40	8.00	0.30	0.15	1.70	Al 1,5-8 BK	3200043	100
④	1.5	16	black	16.00	3.40	10.00	0.30	0.15	1.70	Al 1,5-10 BK	3200195	100
④	1.5	16	black	18.00	3.40	12.00	0.30	0.15	1.70	Al 1,5-12 BK	3201482	100
④	1.5	16	black	24.00	3.40	18.00	0.30	0.15	1.70	Al 1,5-18 BK	3200056	100
④	2.5	14	blue	14.00	4.20	8.00	0.30	0.15	2.30	Al 2,5-8 BU	3200522	100
④	2.5	14	blue	17.00	4.20	10.00	0.30	0.15	2.30	Al 2,5-10 BU	3202533	100
④	2.5	14	blue	18.00	4.20	12.00	0.30	0.15	2.30	Al 2,5-12 BU	3200962	100
④	2.5	14	blue	24.00	4.20	18.00	0.30	0.15	2.30	Al 2,5-18 BU	3200580	100
④	4	12	gray	17.00	4.80	10.00	0.30	0.20	2.80	Al 4-10 GY	3200535	100
④	4	12	gray	20.00	4.80	12.00	0.30	0.20	2.80	Al 4-12 GY	3200959	100
④	4	12	gray	23.00	4.80	15.00	0.30	0.20	2.80	Al 4-15 GY	1200264	100
④	4	12	gray	26.00	4.80	18.00	0.30	0.20	2.80	Al 4-18 GY	3200593	100
④	6	10	yellow	20.00	6.20	12.00	0.30	0.20	3.50	Al 6-12 YE	3200548	100
④	6	10	yellow	26.00	6.20	18.00	0.30	0.20	3.50	Al 6-18 YE	3200603	100
④	10	8	red	22.00	7.50	12.00	0.30	0.20	4.60	Al 10-12 RD	3200551	100
④	10	8	red	28.00	7.50	18.00	0.30	0.20	4.60	Al 10-18 RD	3200616	100
④	16	6	blue	24.00	8.80	12.00	0.40	0.20	5.80	Al 16-12 BU	3200564	100
④	16	6	blue	28.00	8.80	18.00	0.40	0.20	5.80	Al 16-18 BU	3200629	100

# Tools and mounting material

## Mounting material

### Ferrule

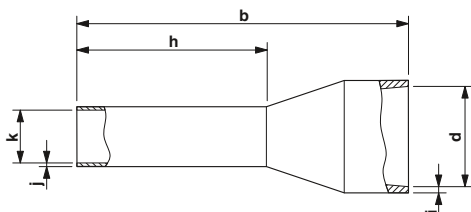

#### Common technical data

Material / coating	CU-DHP / tin-plated (galvanic)
Plastic sleeve material	polypropylene
Long/short-term temperature	105 °C / 120 °C
Approvals	☑
b [mm]	14.00
h [mm]	8.00
j [mm]	0.15

mm <sup>2</sup>	AWG	Color	d [mm]	i [mm]	k [mm]	Type	Item No.	Pcs./Pkt.
0.5	20	white	2.50	0.25	1.10	AI 0,5-8 WH S1	1200104	500
0.75	18	gray	2.80	0.25	1.30	AI 0,75- 8 GY S1	1200105	500
1	18	red	3.00	0.30	1.50	AI 1,0-8 RD S1	1200106	500
1.5	16	black	3.40	0.30	1.80	AI 1,5-8 BK S1	1200107	500
2.5	14	blue	4.20	0.30	2.30	AI 2,5-8 BU S1	1200108	400

Accessories	Type	Item No.	Pcs./Pkt.
Multi-function tool	CRIMPFOX 4 IN 1	1200101	1

### DIN rail



#### Common technical data

Material	Steel
Length	1000 mm
Width	35 mm
Color	white
Slot pattern	Standard elongated hole

Height	Type	Item No.	Pcs./Pkt.
7.5 mm	NS 35/ 7,5 WH PERF 1000MM I	5792163	1
15 mm	NS 35/15 WH PERF 1000MM I	0800121	1

### DIN rail



#### Common technical data

Material	Steel
Length	2000 mm
Width	35 mm

Height	Color	Slot pattern	Type	Item No.	Pcs./Pkt.
7.5 mm	silver	Standard elongated hole	NS 35/ 7,5 WH PERF 2000MM	1204119	25
15 mm	white	Standard elongated hole	NS 35/15 WH PERF 2000MM	0806602	25
7.5 mm	silver	Unperforated	NS 35/ 7,5 WH UNPERF 2000MM-VPE 10	1204122	10
15 mm	silver	Unperforated	NS 35/15 WH UNPERF 2000MM-VPE 10	1204135	10



## DIN rail



### Common technical data

Material	Steel
Length	2000 mm
Width	35 mm

Height	Color	Slot pattern	Type	Item No.	Pcs./Pkt.
7.5 mm	white aluminum	Standard elongated hole	NS 35/ 7,5 BLK PERF 2000MM	0801759	25
7.5 mm	silver	Unperforated	NS 35/ 7,5 BLK UNPERF 2000MM	0801775	25
15 mm	white aluminum	Standard elongated hole	NS 35/15 BLK PERF 2000MM-VPE 10	1208018	10
15 mm	white aluminum	Unperforated	NS 35/15 BLK UNPERF 2000MM-VPE 10	1201701	10

## End block



### Common technical data

Material	PA
Flammability rating according to UL 94	V0
Mounting type	Screw on

Length	Width	Height	DIN rail	Type	Item No.	Pcs./Pkt.
50.5 mm	9.5 mm	35.3 mm	NS 35/7,5; NS 35/15; NS 32	E/TB	3246966	50
55.5 mm	10 mm	50 mm	NS 35/7,5; NS 35/15; NS 32	E/TB H	3246973	50
50.5 mm	9.5 mm	35.3 mm	NS 35/7,5; NS 35/15	E/NS 35 N BK	0804271	50

Accessories	Type	Item No.	Pcs./Pkt.
Terminal strip marker carrier	KLM-A	1004348	100

## End block



### Technical data

Length	48.5 mm
Width	5.15 mm
Height	35 mm
Material	PA
Flammability rating according to UL 94	V0
DIN rail	NS 35/7,5; NS 35/15
Mounting type	Snap on

Type	Item No.	Pcs./Pkt.
TBCLIP 35-5	1093082	1

## Cable duct, gray, PVC

Cable duct for installation and mounting in control cabinets, gray, comprising upper part and mounting base, width: 25 mm, height: 25 mm, length: 2000 mm



### Technical data

Width x Height	25 mm x 25 mm
Length	2000 mm
Material	PVC
Flammability rating according to UL 94	V0
Color	gray
Mounting	Screws and rivets
Ambient temperature (operation)	-5 °C ... 60 °C

Type	Item No.	Pcs./Pkt.
CD 25X25	3240187	25

# Tools and mounting material

## Mounting material

---

### Cable tie

Cable binders for quick and secure bundling, standard version



Width	Length	Type	Item No.	Pcs./Pkt.
3.6 mm	140 mm	WT-HF 3,6X140	3240744	100
3.6 mm	200 mm	WT-HF 3,6X200	3240748	100
3.6 mm	290 mm	WT-HF 3,6X290	3240752	100
4.5 mm	160 mm	WT-HF 4,5X160	3240756	100



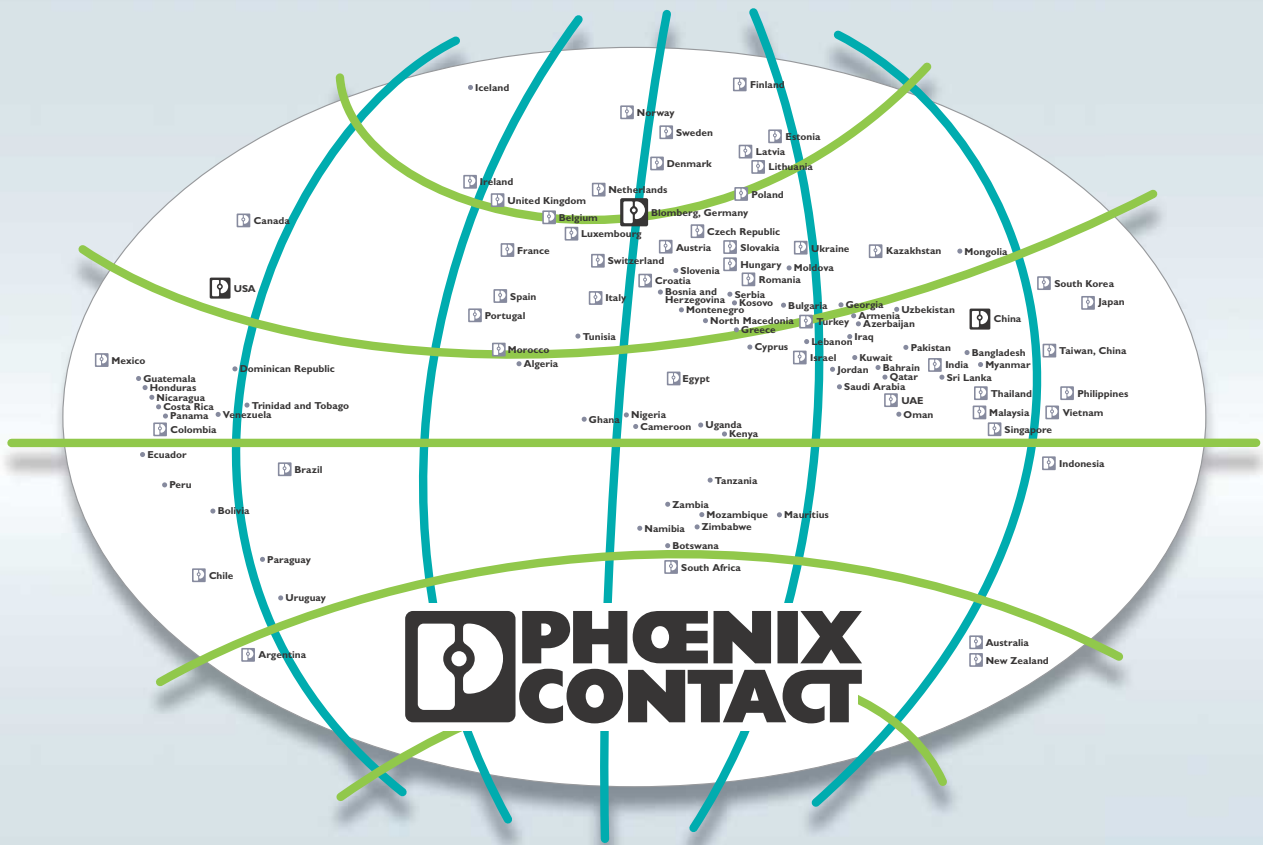

## Open communication with customers and partners worldwide

Phoenix Contact is a global market leader based in Germany. We are known for producing future-oriented products and solutions for the electrification, networking, and automation of all sectors of the economy and infrastructure. With a global network reaching across more than 100 countries with over 20,000 employees, we maintain close relationships with our customers, something we believe is essential for our common success.

Our wide range of innovative products makes it easy for our customers to implement the latest technology in a variety of applications and industries. This especially applies to the target markets of energy, infrastructure, industry, and mobility.

You can find your local partner at  
[phoenixcontact.com](https://www.phoenixcontact.com)